

ESD

选型手册

公司网址: www.wpmsemi.com
技术支持: support@wpmsemi.com

ESD选型手册

目录 (按封装形式)

1	DFN0603-2L	3
2	DFN1006-2L	4
3	DFN1006-3L	7
4	DFN1515-6L	8
5	DFN1610-2L	9
6	DFN1610-6L	10
7	DFN1616-6L	11
8	DFN1713-8L	12
9	DFN2010-8L	13
10	DFN2020-3L	14
11	DFN2020-6L	15
12	DFN2510-10L	16
13	DFN3020-10L	17
14	DFN3316-16L	18
15	DFN3810-9L	19
16	DFN4016-16L	20
17	DFN4120-10L	21
18	DFN5515-18L	22



19	SOD-123FL	23
20	SOD-323	24
21	SOD-523	29
22	SOD-923	30
23	SOT-23	31
24	SOT-143	33
25	SOT23-6L	34
26	SOT-323	36
27	SOT-353	37
28	SOT-363	38
29	SOT-523	39
30	SOT-553	40
31	SOT-563	41
32	SOP-8	42
33	MSOP-8	43
34	MSOP-10	44
35	TSLP-4-7	45

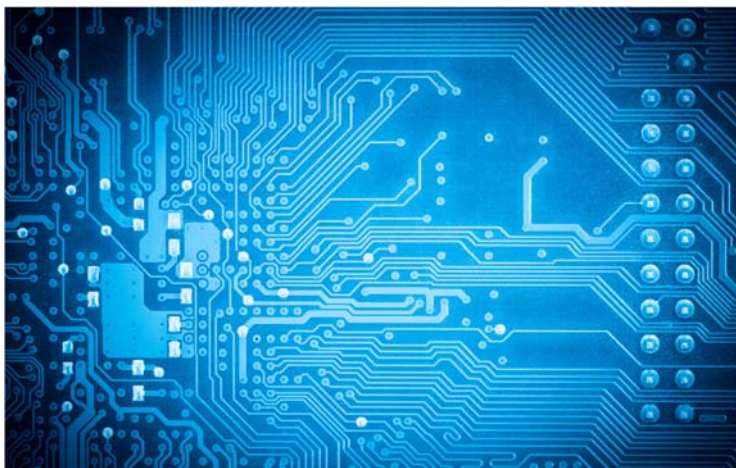

瞬态电压抑制器阵列 ESD/TVS Array

DFN0603-2L封装产品

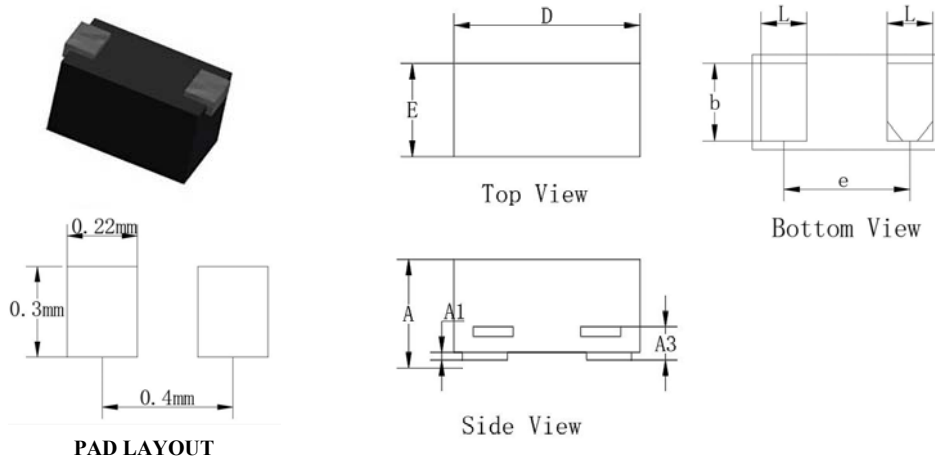

DIM	Millimeters	
	Min	Max
A	0.23	0.33
A1	0.00	0.05
A3	0.12REF	
D	0.55	0.65
E	0.25	0.35
B	0.20	0.27
L	0.12	0.23
E	0.40BSC	

Part NO.	Description	工作电压	动作电压	箝位电压	泄漏电流	结电容	极限电流	功能图
		VRWM	VBR	VC@1A	IR	CJ	Ipp	Fig
		V	V	V	uA	pF	A	
CLAMP3321PS	3.3V, 1-Line, Bi, UltraLow Cap	3.3	4	13	0.1	0.15		Fig 1
CLAMP3321PSCR	3.3V, 1-Line, Bi, UltraLow Cap	3.3	4	4.2	0.1	0.18		Fig 1
CLAMP0521PS	5V, 1-Line, Bi, UltraLow Cap	5	6	9.8	0.1	0.15		Fig 1
CLAMP0521PS1	5.5V, 1-Line, Bi, UltraLow Cap	5.5	6	11	0.1	0.17		Fig 1
CLAMP0521PSCR	5.5V, 1-Line, Bi, UltraLow Cap	5.5	6	4.5	0.1	0.18		Fig 1
CLAMP0521PSCR1	5.5V, 1-Line, Bi, UltraLow Cap	5.5	6	3.2	0.01	0.14		Fig 1
WPE3V3DN02B1LA	3.3V, 1-Line, Bi	3.3	3.8	7.6	1	13	7	Fig 1
WPE3V3DN02B1LB	3.3V, 1-Line, Bi	3.3	3.8	6	1	13	5	Fig 1
WPE3V3DN02B1LF	3.3V, 1-Line, Bi	3.3	3.8	7.6	1	5.6	5	Fig 1
WPE3V3DN02B1LN	3.3V, 1-Line, Bi	3.3	3.8	5.5	0.5	34		Fig 1
WPE5V0N02B1LA	5V, 1-Line, Bi	5	6	8.5	0.1	5.5		Fig 1
WPE5V0N02B1LB	5V, 1-Line, Bi	5	6	9.8	0.1	2.5		Fig 1
WPE5V0DN02B1LF	5.5V, 1-Line, Bi	5.5	6	6.8	0.3	16	6	Fig 1
WPE18VDN02B1TA	18V, 1-Line, Bi, UltraLow Cap	18	19	16	0.1	0.28	1	Fig 1

功能图标识

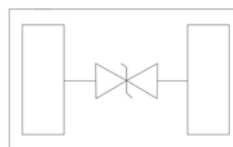
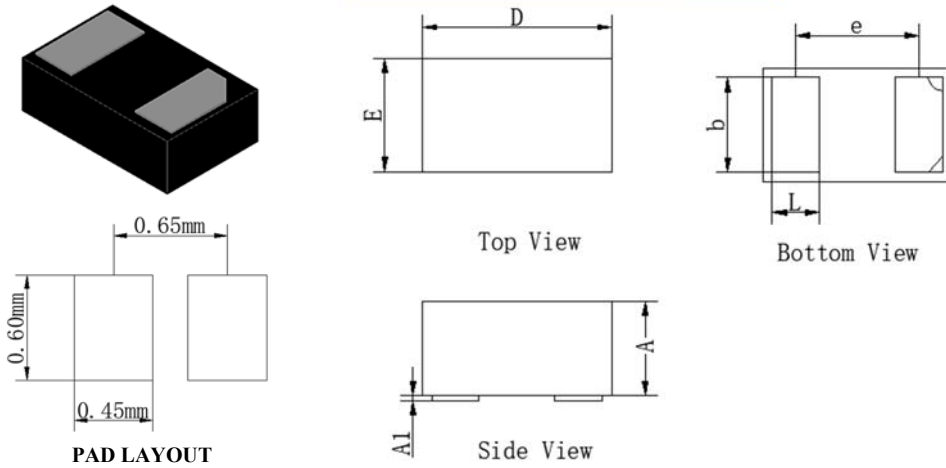

Fig 1

对应型号系列	包装形式	卷盘直径	每盘/盒数量	每箱数量	外包装箱尺寸		
		mm	PCS	PCS	L(mm)	W(mm)	H(mm)
DFN0603-2L封装产品	盘装	178	15,000	600,000	438	438	220

瞬态电压抑制器阵列 ESD/TVS Array

DFN1006-2L封装产品



DIM	Millimeters	
	Min	Max
A	0.37	0.55
A1	0.00	0.05
D	0.95	1.05
E	0.48	0.65
b	0.35	0.55
e	0.65TYP	
L	0.15	0.35

Part NO.	Description	工作电压	动作电压	箝位电压	泄漏电流	结电容	极限电流	功能图
		VRWM	VBR	VC@1A	IR	CJ	IPP	Fig
		V	V	V	uA	pF	A	
CLAMP0211P	1.8V, 1-Line, Bi	1.8	3.4	3.5	1	45		Fig 1
CLAMP0351P	3.3V, 1-Line, Bi	3.3	4.5	10	0.1	32	12	Fig 1
CLAMP0511P	5V, 1-Line, Bi	5	5.8	7.2	0.5	15	6	Fig 1
CLAMP0521P	5V, 1-Line, Bi, UltraLow Cap	5	6	15	1	0.17		Fig 1
CLAMP0521P1	5V, 1-Line, Bi, UltraLow Cap	5	6	15	0.2	0.17		Fig 1
CLAMP0521PCR	5.5V, 1-Line, Bi, UltraLow Cap	5.5	6	4.5	0.1	0.18		Fig 1
CLAMP0541P	5V, 1-Line, Uni, UltraLow Cap	5	6	9.8	0.01	0.4	4	Fig 2
CLAMP0541PCR	5V, 1-Line, Uni, UltraLow Cap	5	6	4.5	0.5	0.5		Fig 2
CLAMP0541PH	5V, 1-Line, Uni, UltraLow Cap	5	5.8	7.3	0.01	0.65	8	Fig 2
CLAMP0551P	5V, 1-Line, Bi	5	5.5	7.4	0.1	32	12	Fig 1
CLAMP0551P1	5V, 1-Line, Bi	5	5.5	7	0.1	13	6	Fig 1
CLAMP0711P	6.5V, 1-Line, Bi	6.5	6.5	8.8	0.5	14	5	Fig 1
CLAMP0811P	8V, 1-Line, Bi	8	8	10	0.5	15	5	Fig 1
CLAMP0901P	9V, 1-Line, Bi	9	10	12.5	0.5	130		Fig 1
CLAMP1201P	12V, 1-Line, Uni	12	13.3	15	0.5	105		Fig 2
CLAMP1201P1	12V, 1-Line, Uni	12	13.3	15	0.5	80		Fig 2

功能图标识

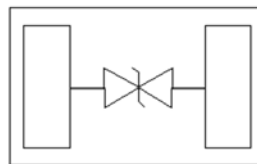

Fig 1

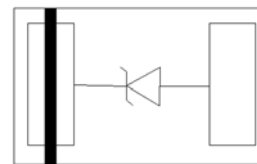
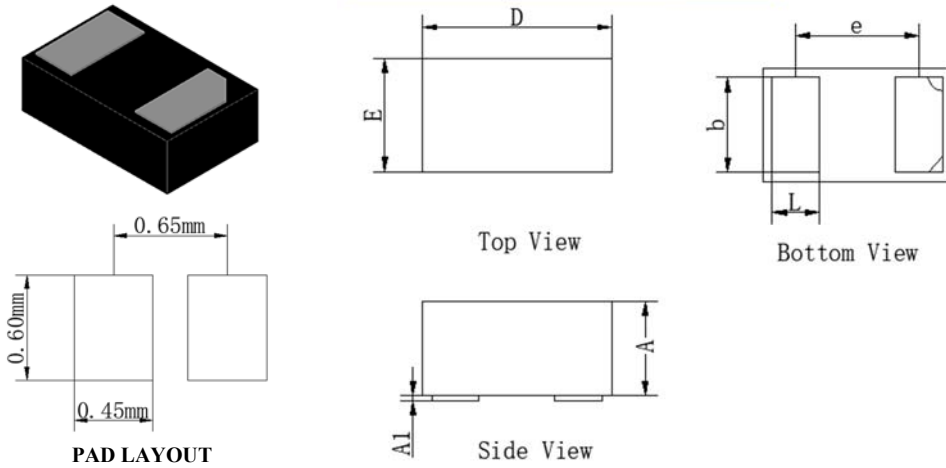

Fig 2

对应型号系列	包装形式	卷盘直径	每盘/盒数量	每箱数量	外包装箱尺寸		
		mm	PCS	PCS	L(mm)	W(mm)	H(mm)
DFN1006-2L封装产品	盘装	178	10,000	400,000	438	438	220

瞬态电压抑制器阵列 ESD/TVS Array

DFN1006-2L封装产品



DIM	Millimeters	
	Min	Max
A	0.37	0.55
A1	0.00	0.05
D	0.95	1.05
E	0.48	0.65
b	0.35	0.55
e	0.65TYP	
L	0.15	0.35

Part NO.	Description	工作电压	动作电压	箝位电压	泄漏电流	结电容	极限电流	功能图
		VRWM	VBR	VC@1A	IR	CJ	IPP	Fig
		V	V	V	uA	pF	A	
CLAMP1211P	12V, 1-Line, Bi	12	13.3	19	0.2	35		Fig 1
CLAMP1211P1	12V, 1-Line, Bi	12	13.3	19	0.2	10		Fig 1
CLAMP1801P	18V, 1-Line, Uni	18	19	23	0.5	60		Fig 2
CLAMP2001P	20V, 1-Line, Uni	20	20	24	0.5	60		Fig 2
CLAMP2401P	24V, 1-Line, Uni	24	25.5	38	1	42		Fig 2
CLAMP2411P	24V, 1-Line, Bi	24	26.7	35	0.2	18		Fig 1
CLAMP3311P	3.3V, 1-Line, Bi	3.3	3.3	4	0.1	17	10	Fig 1
CLAMP3311P1	3.3V, 1-Line, Bi	3.3	4	4	0.1	9	6	Fig 1
CLAMP3311P2	3.3V, 1-Line, Bi	3.3	4	7.6	1	18		Fig 1
CLAMP3321P	3.3V, 1-Line, Bi, UltraLow Cap	3.3	4.6	10	1	0.15		Fig 1
CLAMP3341P	3.3V, 1-Line, Uni, UltraLow Cap	3.3	4	7.5	1	0.3	4	Fig 2
CLAMP3611P	36V, 1-Line, Bi	36	40	65	1	14		Fig 1
CLAMP6301P	6.3V, 1-Line, Uni	6.3	7	8.4	1	180	22	Fig 2
CLAMP0501F1	5V, 1-Line, Uni	5	6	8.7	1	150	22	Fig 2
CLAMP0511T	5V, 1-Line, Bi	5	5.6	10.6	1	7	3	Fig 1
CLAMP0511T1	5V, 1-Line, Bi	5	6	10.6	1	7	3	Fig 1
CLAMP0511T2	5V, 1-Line, Bi	5	6	11.8	0.1	2.2	1	Fig 1

功能图标识

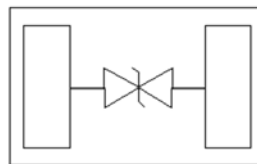

Fig 1

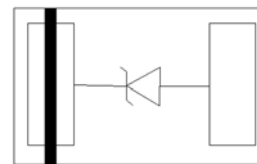
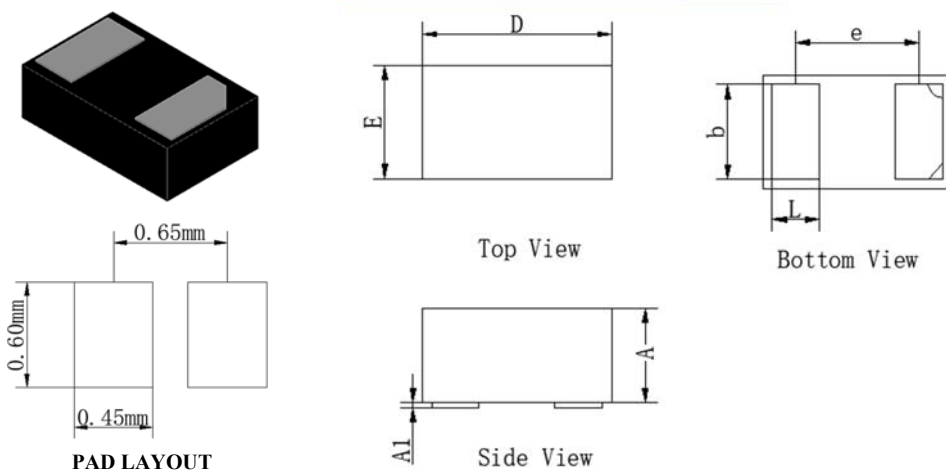

Fig 2

对应型号系列	包装形式	卷盘直径	每盘/盒数量	每箱数量	外包装箱尺寸		
		mm	PCS	PCS	L(mm)	W(mm)	H(mm)
DFN1006-2L封装产品	盘装	178	10,000	400,000	438	438	220

瞬态电压抑制器阵列 ESD/TVS Array

DFN1006-2L封装产品



DIM	Millimeters	
	Min	Max
A	0.37	0.55
A1	0.00	0.05
D	0.95	1.05
E	0.48	0.65
b	0.35	0.55
e	0.65TYP	
L	0.15	0.35

Part NO.	Description	工作电压	动作电压	箝位电压	泄漏电流	结电容	极限电流	功能图
		VRWM	VBR	VC@1A	IR	CJ	IPP	Fig
		V	V	V	uA	pF	A	
CLAMP0521T	5V, 1-Line, Bi, UltraLow Cap	5	5.4	12.5	1	0.9		Fig 1
CLAMP1221T	12V, 1-Line, Bi, UltraLow Cap	12	13.3	20	1	0.6		Fig 1
CLAMP1241T	12V, 1-Line, Uni	12	13.3	17.5	0.5	1.3		Fig 2
CLAMP1521T	15V, 1-Line, Bi, UltraLow Cap	15	15.5	20.5	0.5	0.62		Fig 1
CLAMP1541T	15V, 1-Line, Uni	15	15.5	19	0.5	1.3		Fig 2
CLAMP1821T	18V, 1-Line, Bi, UltraLow Cap	18	20	32	1	0.19		Fig 1
CLAMP2021T	20V, 1-Line, Bi, UltraLow Cap	20	22	32	1	0.19		Fig 1
CLAMP2321T	23V, 1-Line, Bi, UltraLow Cap	23	23.2	32	1	0.19		Fig 1
CLAMP3311T	3.3V, 1-Line, Bi	3.3	4	7.6	5	95		Fig 1
CLAMP3311T3	3.3V, 1-Line, Bi	3.3	3.6	6.5	1	65		Fig 1
WPE7V0N04B1L	7V, 1-Line, Bi	7	9.4	10.4	0.1	4.5	6	Fig 1

功能图标识

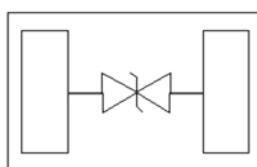

Fig 1

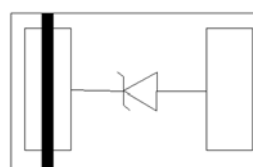
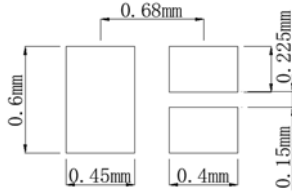
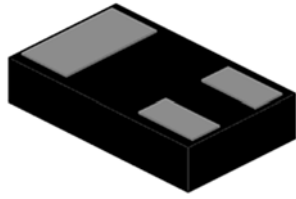

Fig 2

对应型号系列	包装形式	卷盘直径	每盘/盒数量	每箱数量	外包装箱尺寸		
		mm	PCS	PCS	L(mm)	W(mm)	H(mm)
DFN1006-2L封装产品	盘装	178	10,000	400,000	438	438	220

瞬态电压抑制器阵列 ESD/TVS Array

DFN1006-3L封装产品



PAD LAYOUT

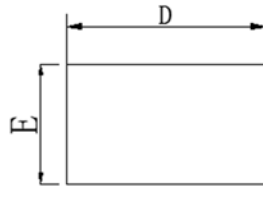

Top View

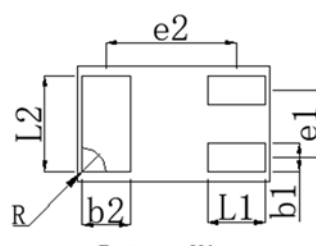

Bottom View

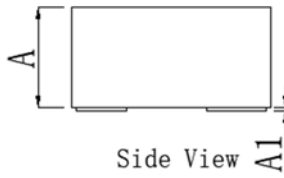

Side View

DIM	Millimeters	
	Min	Max
A	0.46	0.51
A1	0.00	0.05
D	0.95	1.05
E	0.55	0.65
b1	0.10	0.20
b2	0.20	0.30
L1	0.20	0.30
L2	0.45	0.55
e1	0.325BSC	
R	0.05	0.15

Part NO.	Description	工作电压	动作电压	箝位电压	泄漏电流	结电容	极限电流	功能图
		VRWM	VBR	VC@1A	IR	CJ	IPP	Fig
		V	V	V	uA	pF	A	
WPE05CN92BL	5V, 2-Line, Bi	5	6	9.3	0.3	2.8	2	Fig2
WPE05CN92BL1A	5V, 2-Line, Bi	5	6	11.8	0.1	2.2	2	Fig2
WPE05VN92ULA	5.5V, 2-Line, Uni, UltraLow Cap	5.5	6	3.4	0.1	0.45		Fig 1
WPE03VN92U1L2	3.3V, 2-Line, Uni, UltraLow Cap	3.3	4	8.4	0.1	0.45		Fig 1
WPE05VN92U1L2	5V, 2-Line, Uni, UltraLow Cap	5	5.5	8.4	0.1	0.35		Fig 1

功能图标识

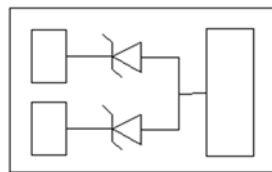

Fig 1

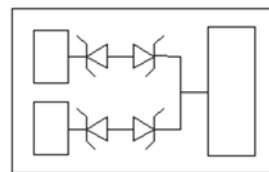
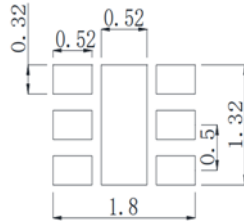

Fig 2

对应型号系列	包装形式	卷盘直径	每盘/盒数量	每箱数量	外包装箱尺寸		
		mm	PCS	PCS	L(mm)	W(mm)	H(mm)
DFN1006-3L封装产品	盘装	178	10,000	400,000	438	438	220

瞬态电压抑制器阵列 ESD/TVS Array

DFN1515-6L封装产品



PAD LAYOUT

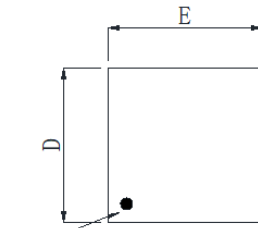

Top View

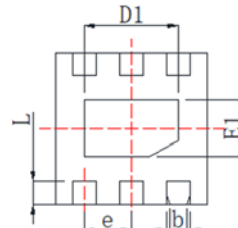

Bottom View

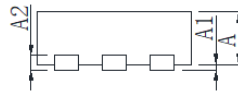

Side View

DIM	Millimeters	
	Min	Max
A	0.50	0.60
A1	0.05REF	
A2	0.125REF	
b	0.20	0.30
b1	0.18REF	
D	1.40	1.60
E	1.400	1.60
D1	0.90	1.10
E1	0.36	0.56
e	0.50REF	
L	0.174	0.326

Part NO.	Description	工作电压	动作电压	箝位电压	泄漏电流	结电容	极限电流	功能图
		VRWM	VBR	VC@1A	IR	CJ	IPP	Fig
		V	V	V	uA	pF	A	
CLAMP0563P	5.5V, 6-Line, Bi, UltraLow Cap	5.5	9	9.8	0.1	0.35	5	Fig 1
WPE0503N	6.5V, 6-Line, Bi, UltraLow Cap	6.5	7	9.5	0.1	0.25		Fig 1

功能图标识

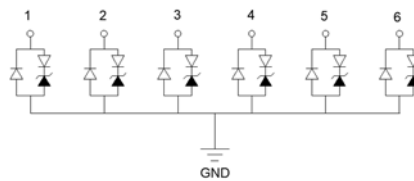
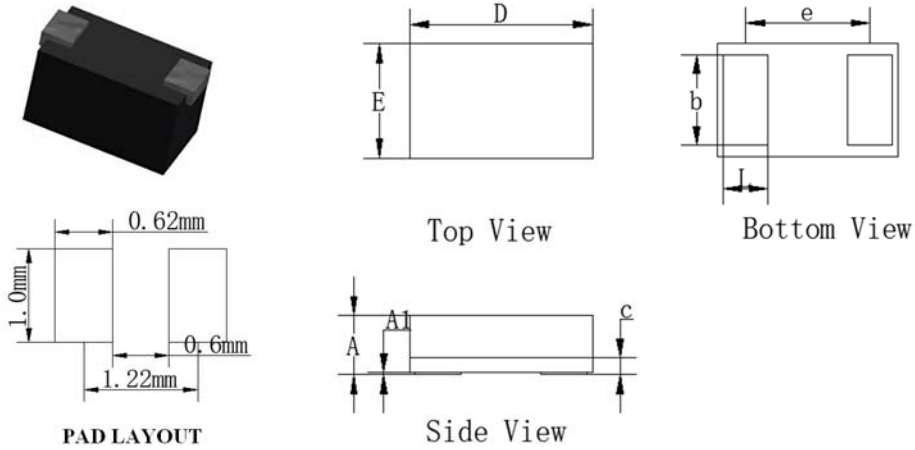

Fig 1

对应型号系列	包装形式	卷盘直径	每盘/盒数量	每箱数量	外包装箱尺寸		
		mm	PCS	PCS	L(mm)	W(mm)	H(mm)
DFN1515-6L封装产品	盘装	178	3,000	120,000	438	438	220

瞬态电压抑制器阵列 ESD/TVS Array

DFN1610-2L封装产品



DIM	Millimeters	
	Min	Max
A	0.45	0.55
A1	0.00	0.05
b	0.75	0.95
c	0.10	0.20
D	1.55	1.65
e	1.10BSC	
E	0.12	0.23
L	0.35	0.45

Part NO.	Description	工作电压	动作电压	箝位电压	泄漏电流	结电容	极限电流	功能图
		VRWM	VBR	VC@1A	IR	CJ	IPP	Fig
		V	V	V	uA	pF	A	
WPE4V5N16AT1L1	4.5V, 1-Line, Uni	4.5	5.3	7@10	1	580	170	Fig 1
WPE5V0N16AT1L1	5V,1-Line, Uni	5	6	9.8@10	1	920	100	Fig 1
WPE7V0N16AT1L1	7V, 1-Line, Uni	7	8	10.5@10	1	810	80	Fig 1
WPE12VN16AT1L1	12V, 1-Line, Uni	12	13	16.9@10	1	410	60	Fig 1
WPE15VN16AT1L1	15V, 1-Line, Uni	15	16	20.5@10	1	390	50	Fig 1
WPT4V5N16BT1L1	4.5V, 1-Line, Bi	4.5	4.6	9.1@100	1	400	170	Fig 2

功能图标识

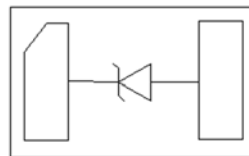

Fig 1

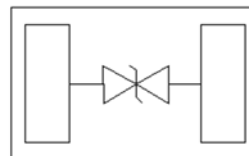
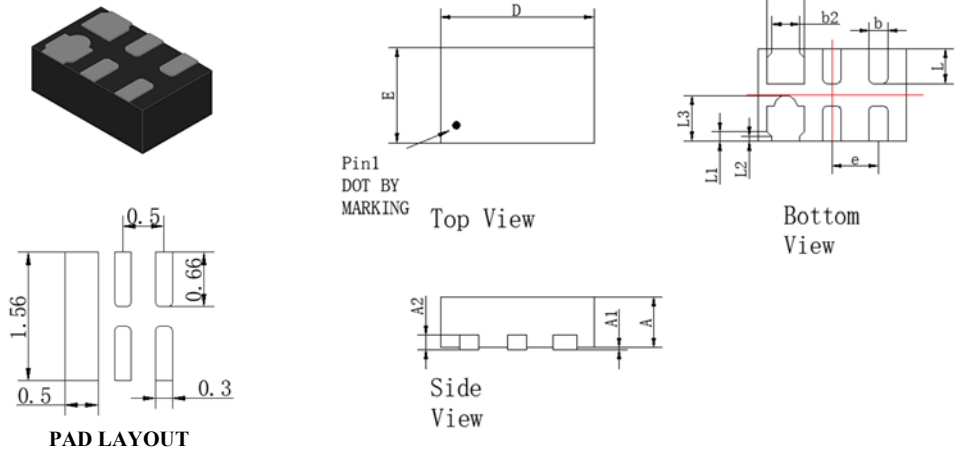

Fig 2

对应型号系列	包装形式	卷盘直径	每盘/盒数量	每箱数量	外包装箱尺寸		
		mm	PCS	PCS	L(mm)	W(mm)	H(mm)
DFN1610-2L封装产品	盘装	178	10,000	400,000	438	438	220

瞬态电压抑制器阵列 ESD/TVS Array

DFN1610-6L封装产品



DIM	Millimeters	
	Min	Max
A	0.49	0.60
A1	0.05REF	
A2	0.15REF	
b	0.15	0.25
b1	0.35	0.45
b2	0.20REF	
D	1.55	1.65
e	0.50BSC	
L	0.99	0.43
L1	0.10REF	
L2	0.05REF	
L3	0.49REF	

Part NO.	Description	工作电压	动作电压	箝位电压	泄漏电流	结电容	极限电流	功能图
		VRWM	VBR	VC@1A	IR	CJ	IPP	Fig
		V	V	V	uA	pF	A	
CLAMP0522P	5V, 2-Line, Uni, UltraLow Cap	5	6	8.7	1	0.5	3	Fig 1

功能图标识

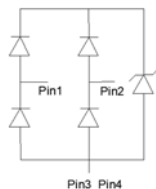
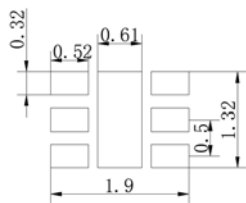
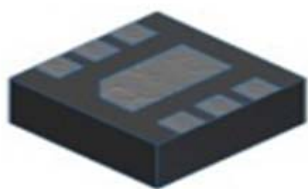

Fig 1

对应型号系列	包装形式	卷盘直径	每盘/盒数量	每箱数量	外包装箱尺寸		
		mm	PCS	PCS	L(mm)	W(mm)	H(mm)
DFN1610-6L封装产品	盘装	178	3,000	120,000	438	438	220

瞬态电压抑制器阵列 ESD/TVS Array

DFN1616-6L封装产品



PAD LAYOUT

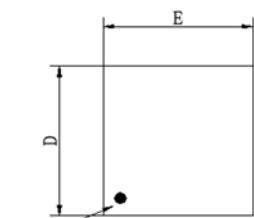

Top View

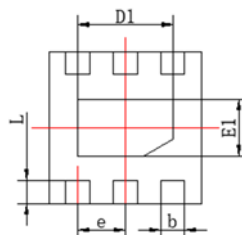

Bottom View

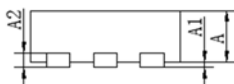

Side View

DIM	Millimeters	
	Min	Max
A	0.45	0.63
A1	0.05REF	
A2	0.15REF	
b	0.20	0.30
D	1.55	1.65
D1	0.90	1.10
E	1.55	1.65
E1	0.50	0.70
L	0.164	0.316
E	0.50REF	

Part NO.	Description	工作电压	动作电压	箝位电压	泄漏电流	结电容	极限电流	功能图
		VRWM	VBR	VC@1A	IR	CJ	IPP	Fig
		V	V	V	uA	pF	A	
CLAMP0504P	5V, 4-Line, Uni	5	6	15.5	1	1	5	Fig 2
CLAMP0506P	5V, 6-Line, Bi	5	6	8.5	1	50	10	Fig 1

功能图标识

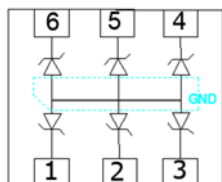

Fig 1

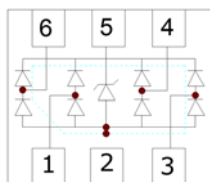
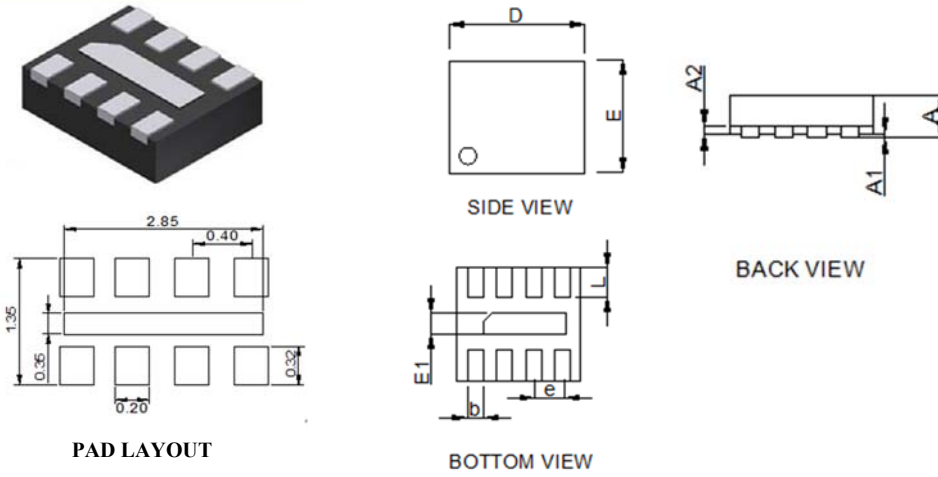

Fig 2

对应型号系列	包装形式	卷盘直径	每盘/盒数量	每箱数量	外包装箱尺寸		
		mm	PCS	PCS	L(mm)	W(mm)	H(mm)
DFN0603-2L封装产品	盘装	178	3,000	120,000	438	438	220

瞬态电压抑制器阵列 ESD/TVS Array

DFN1713-8L封装产品



DIM	Millimeters	
	Min	Max
A	0.45	0.65
A1	0.00	0.05
A2	0.15BSC	
b	0.15	0.25
D	1.625	1.775
D1	1.10	1.30
E	0.12	0.23
E1	0.25	0.50
L	0.18	0.38
e	0.40REF	

Part NO.	Description	工作电压	动作电压	箝位电压	泄漏电流	结电容	极限电流	功能图
		VRWM	VSIG	VC@1A	IR	CJ	IPP	Fig
		V	V	V	uA	pF	A	
WP9401	5V, 2-Line, Uni	5	6.8 -0.8	9	1	12		Fig 1

功能图标识

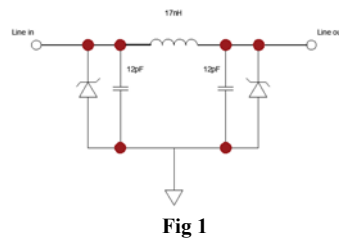

对应型号系列	包装形式	卷盘直径	每盘/盒数量	每箱数量	外包装箱尺寸		
		mm	PCS	PCS	L(mm)	W(mm)	H(mm)
DFN1713-8L封装产品	盘装	178	3,000	120,000	438	438	220

瞬态电压抑制器阵列 ESD/TVS Array

DFN2010-8L封装产品

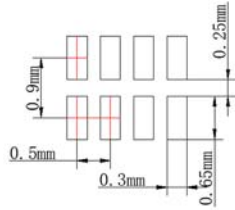
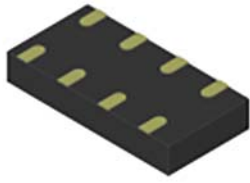

PAD LAYOUT

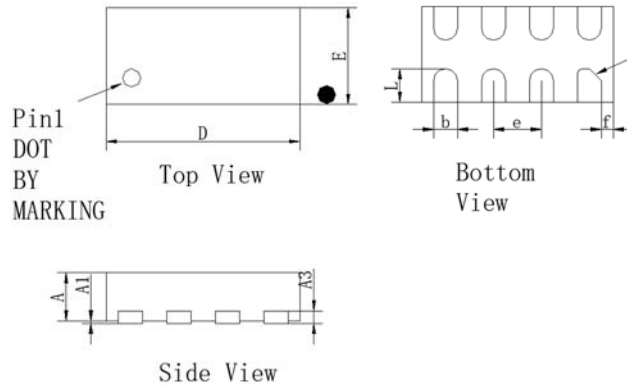

Pin1 IDENTIFICATION CHAMFER

DIM	Millimeters	
	Min	Max
A	0.40	0.50
A1	0.00	0.05
A3	0.125REF	
D	1.95	2.05
E	0.95	1.05
b	0.20	0.30
L	0.30	0.40
e	0.50BSC	
f	0.125REF	

Part NO.	Description	工作电压	动作电压	箝位电压	泄漏电流	结电容	极限电流	功能图
		VRWM	VBR	VC@1A	IR	CJ	IPP	Fig
		V	V	V	uA	pF	A	
WPE2512T	2.5V, 4-Line, Bi	2.5	2.8 3.5	9	0.05	1.4		Fig 1
CLAMP2512TP1	2.5V, 4-Line, Bi, UltraLow Cap	2.5	2.8 2.5	5.6	0.05	0.47		Fig 1

功能图标识

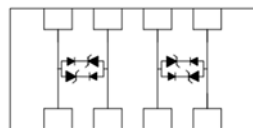
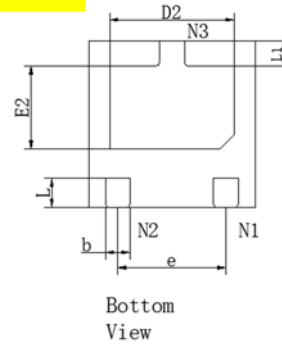
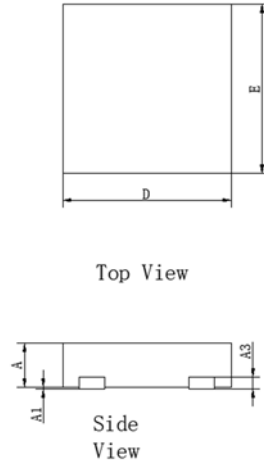
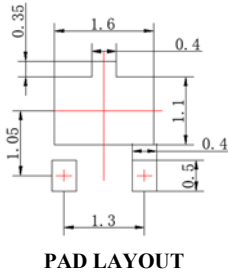

Fig 1

对应型号系列	包装形式	卷盘直径	每盘/盒数量	每箱数量	外包装箱尺寸		
		mm	PCS	PCS	L(mm)	W(mm)	H(mm)
DFN2010-8L封装产品	盘装	178	3,000	120,000	438	438	220

瞬态电压抑制器阵列 ESD/TVS Array

DFN2020-3L封装产品



DIM	Millimeters	
	Min	Max
A	0.50	0.60
A1	0.00	0.05
A3	0.15REF	
D	1.95	2.05
E	1.95	2.05
b	0.25	0.35
L	0.30	0.40
L1	0.25	0.35
D2	1.35	1.60
E2	0.85	1.10
E	1.30BSC	

Part NO.	Description	工作电压	动作电压	箝位电压	泄漏电流	结电容	极限电流	功能图
		VRWM	VBR	VC@1A	IR	CJ	IPP	Fig
		V	V	V	uA	pF	A	
WPT4V5N20AT1L1	High Power 4.5V, 1-Line, Uni	4.5	5	12.5 @80	1	400		Fig 1
WPT7V0N20AT1L1	High Power 7V, 1-Line, Uni	7	8.2	17 @270	1	1800		Fig 1
WPT12VN20AT1L1	High Power 12V, 1-Line, Uni	12	13.5	22 @180	1	1100		Fig 1
WPT15VN20AT1L1	High Power 15V, 1-Line, Uni	15	15.8	26.7 @150	1	900		Fig 1
WPT24VN20AT1L1	High Power 24V, 1-Line, Uni	24	25.7	38.6 @80	1	500		Fig 1
WPT4V5N20AT2L1	High Power 4.5V, 1-Line, Uni	4.5	4.85	13 @280	3	3300		Fig 1
WPT12VN20AT2L1	High Power 12V, 1-Line, Uni	12	13.3	20 @220	1	1300		Fig 1
WPT24VN20AT2L1	High Power 24V, 1-Line, Uni	24	25	38 @130	1	700		Fig 1
WPT12VN20AT3L1	High Power 12V, 1-Line, Uni	12	13.5	24.5 @170	1	1300	190	Fig 1
WPT14VN20AT3L1	High Power 14V, 1-Line, Uni	14	15.2	27.5 @160	1	1100	170	Fig 1
WPT17VN20AT3L1	High Power 17V, 1-Line, Uni	17	18.2	30 @130	1	950	150	Fig 1

功能图标识



Fig 1



Fig 2

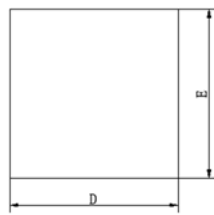
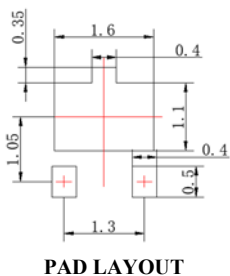
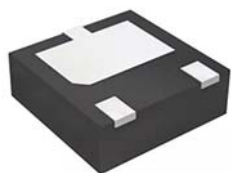

Fig 3

对应型号系列	包装形式	卷盘直径	每盘/盒数量	每箱数量	外包装箱尺寸		
		mm	PCS	PCS	L(mm)	W(mm)	H(mm)
DFN2020-3L封装产品	盘装	178	3,000	120,000	438	438	220

瞬态电压抑制器阵列 ESD/TVS Array

DFN2020-3L封装产品



Top View

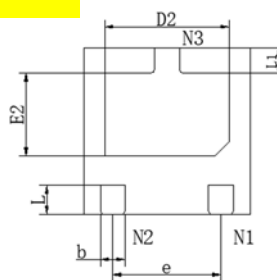

Bottom View

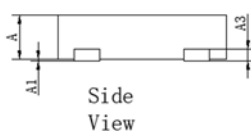

Side View

DIM	Millimeters	
	Min	Max
A	0.50	0.60
A1	0.00	0.05
A3	0.15REF	
D	1.95	2.05
E	1.95	2.05
b	0.25	0.35
L	0.30	0.40
L1	0.25	0.35
D2	1.35	1.60
E2	0.85	1.10
E	1.30BSC	

Part NO.	Description	工作电压	动作电压	箝位电压	泄漏电流	结电容	极限电流	功能图
		VRWM	VBR	VC@1A	IR	CJ	IPP	Fig
		V	V	V	uA	pF	A	
WPT24VN20AT3L1	High Power 24V, 1-Line, Uni	24	25.5	33 @170	1	740		Fig 2
WPT4V5N20BT1L1	High Power 4.5V, 1-Line, Bi	4.5	5	9 @180	1	400		Fig 3
WPT4V5N20BT2L1	High Power 4.5V, 1-Line, Bi	4.5	4.85	12.5 @380	3	800		Fig 3
WPT4V5N20BT3L1	High Power 4.5V, 1-Line, Bi	4.5	4.9	13 @300	1	570		Fig 3
WPE4V5N20BT4L1	High Power 4.5V, 1-Line, Bi	4.5	5	15 @280	1	620		Fig 3

功能图标识



Fig 1



Fig 2

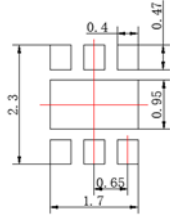
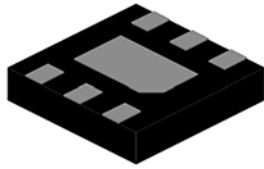

Fig 3

对应型号系列	包装形式	卷盘直径	每盘/盒数量	每箱数量	外包装箱尺寸		
		mm	PCS	PCS	L(mm)	W(mm)	H(mm)
DFN2020-3L封装产品	盘装	178	3,000	120,000	438	438	220

瞬态电压抑制器阵列 ESD/TVS Array

DFN2020-6L封装产品



PA

D

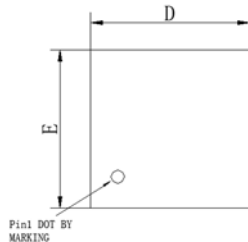

Top View

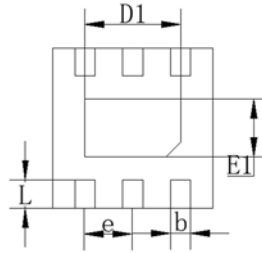

Bottom View

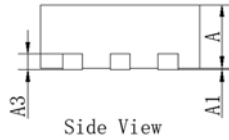

Side View

DIM	Millimeters	
	Min	Max
A	0.75	0.85
A1	0.05REF	
A3	0.203REF	
b	0.20	0.30
D	1.55	2.00
E	1.924	2.067
E1	0.60	0.85
D1	1.10	1.30
e	0.65BSC	
L	0.274	0.426
E2	0.85	1.10

Part NO.	Description	工作电压	动作电压	箝位电压	泄漏电流	结电容	极限电流	功能图
		VRWM	VBR	VC@1A	IR	CJ	IPP	Fig
		V	V	V	uA	pF	A	
CLAMP0504N	5V, 4-Line, Uni	5.0	6.0	15.5	1.0	1.0	5	Fig 1

功能图标识

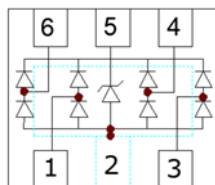
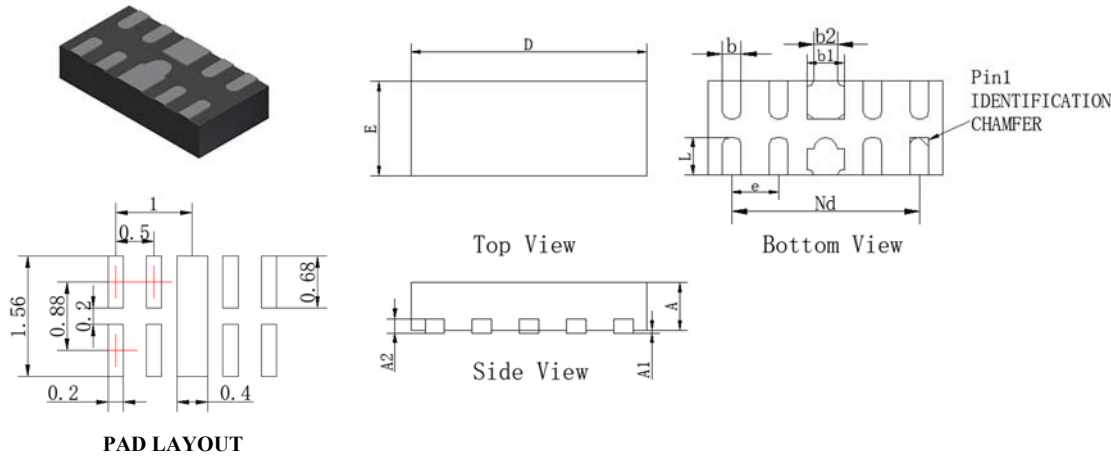

Fig 1

对应型号系列	包装形式	卷盘直径	每盘/盒数量	每箱数量	外包装箱尺寸		
		mm	PCS	PCS	L(mm)	W(mm)	H(mm)
DFN2020-6L封装产品	盘装	178	3,000	120,000	438	438	220

瞬态电压抑制器阵列 ESD/TVS Array

DFN2510-10L封装产品



DIM	Millimeters	
	Min	Max
A	0.45	0.65
A1	0.05REF	
A2	0.15REF	
b	0.15	0.25
b1	0.30	0.50
b2	0.20REF	
D	2.424	2.576
E	0.924	1.076
L	0.30	0.45
e	0.50BSC	
Nd	1.30BSC	

Part NO.	Description	工作电压	动作电压	箝位电压	泄漏电流	结电容	极限电流	功能图
		VRWM V	VBR V	VC@1A V	IR uA	CJ pF	IPP A	Fig
CLAMP3324P	3.3V, 4-Line, Uni, UltraLow Cap	3.3	4	8.6	1	0.45	4	Fig 1
CLAMP3324PCR	3.3V, 4-Line, Uni, UltraLow Cap	3.3	4	5.7	1	0.4		Fig 1
CLAMP3324PCR1	3.3V, 4-Line, Uni, UltraLow Cap	3.3	4	5.7	1	0.35		Fig 1
CLAMP3324PCR2	3.3V, 4-Line, Uni, UltraLow Cap	3.3	4	1	1	0.3		Fig 1
CLAMP0524P	5V, 4-Line, Uni, UltraLow Cap	5	6	9.8	1	0.36	4	Fig 1
CLAMP0524P2	5V, 4-Line, Uni, UltraLow Cap	5	6	8.6	0.5	0.36	3.5	Fig 1
CLAMP0524P3	5V, 4-Line, Uni, UltraLow Cap	5	6	7.8	0.5	0.45	5	Fig 1
CLAMP0524P5	5V, 4-Line, Uni, UltraLow Cap	5	6	6.5	0.5	0.36	3.5	Fig 1
CLAMP0524PCR1	1.5V, 4-Line, Uni, UltraLow Cap	1.5	9	1.7	1	0.45		Fig 1
CLAMP0524P_ULC	5V, 4-Line, Uni, UltraLow Cap	5	6	6	1	0.45		Fig 1
CLAMP0524PU	5V, 4-Line, Bi, UltraLow Cap	5	6	9.7	0.5	0.16	2	Fig 2

功能图标识

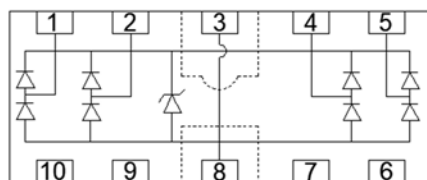

Fig 1

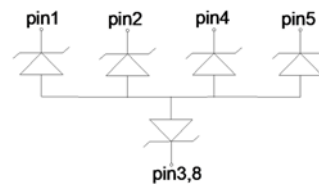
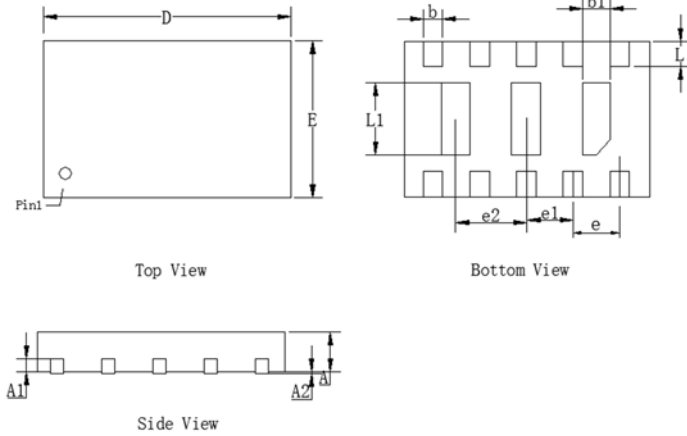
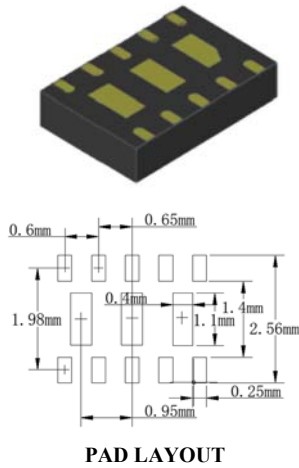

Fig 2

对应型号系列	包装形式	卷盘直径	每盘/盒数量	每箱数量	外包装箱尺寸		
		mm	PCS	PCS	L(mm)	W(mm)	H(mm)
DFN2510-10L封装产品	盘装	178	3,000	120,000	438	438	220

瞬态电压抑制器阵列 ESD/TVS Array

DFN3020-10L封装产品



DIM	Millimeters	
	Min	Max
A	0.40	0.50
A1	0.00 0.05	
A2	0.00	0.05
b	0.15	0.25
b1	0.30	0.40
D	2.95	3.05
E	1.95	2.05
L	0.20	0.40
L1	0.90	1.10
e	0.60BSC	
e1	0.65BSC	
e2	0.95BSC	

Part NO.	Description	工作电压	动作电压	箝位电压	泄漏电流	结电容	极限电流	功能图
		VRWM	VBR	VC@1A	IR	CJ	IPP	Fig
		V	V	V	uA	pF	A	
CLAMP2574N	2.5V, 4-Line, Uni	2.5	2.0 2.5	5.0	0.35	3.65	40	Fig 1
CLAMP2574N2	2.5V, 4-Line, Uni	2.5	2.0 2.5	4.5	0.35	4.1	40	Fig 1
WPE2574NP2	2.5V, 4-Line, Uni	2.5	2.7	10	0.1	1.9	40	Fig 1
CLAMP2574NUD	2.5V, 4-Line, Uni	2.5	2.5 2.0	4.5	0.35	4.1	40	Fig 1
CLAMP3374N	3.3V, 4-Line, Uni	3.3	3.5 2.8	5.2	0.5	2.4	40	Fig 1
CLAMP3374N2	3.3V, 4-Line, Uni	3.3	2.8 3.5	4.5	0.35	4.1	40	Fig 1
WPE3374NP2	3.3V, 4-Line, Uni	3.3	3.0	10	0.1	1.7	40	Fig 1
WPE0534N	5V, 4-Line, Uni	5	6	±4.5	0.1	1.4	25	Fig 1

功能图标识

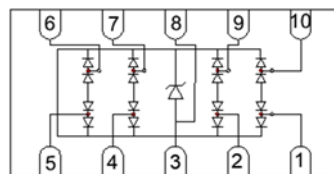
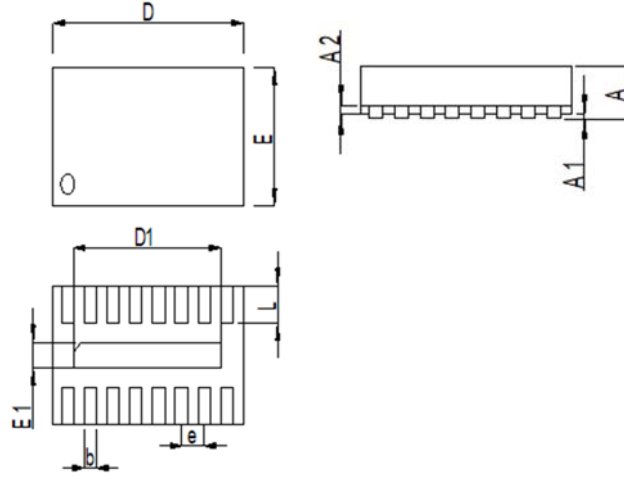
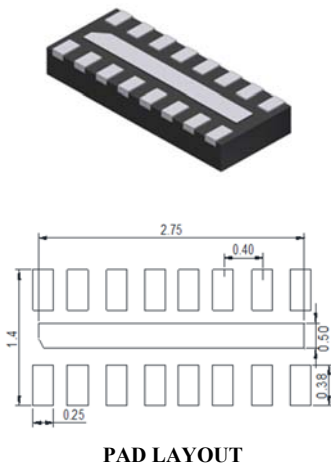

Fig 1

对应型号系列	包装形式	卷盘直径	每盘/盒数量	每箱数量	外包装箱尺寸		
		mm	PCS	PCS	L(mm)	W(mm)	H(mm)
DFN3020-10L封装产品	盘装	178	3,000	120,000	438	438	220

瞬态电压抑制器阵列 ESD/TVS Array

DFN3316-16L封装产品



DIM	Millimeters	
	Min	Max
A	0.50	0.65
A1	0.00	0.05
A2	0.13BSC	
b	0.15	0.25
D	3.25	3.35
D1	2.45	2.75
E	1.30	1.40
E1	0.25	0.50
e	0.125REF	
L	0.18	0.38

Part NO.	Description	工作电压	动作电压	箝位电压	泄漏电流	结电容	极限电流	功能图
		VRWM	VBR	VC@1A	IR	CJ	IPP	Fig
		V	V	V	uA	pF	A	
WP9801	5V, 2-Line, Uni	5	6.8	0.1	1	12		Fig 1

功能图标识

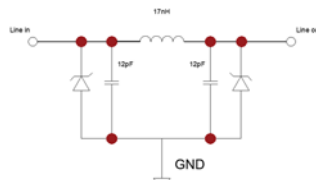
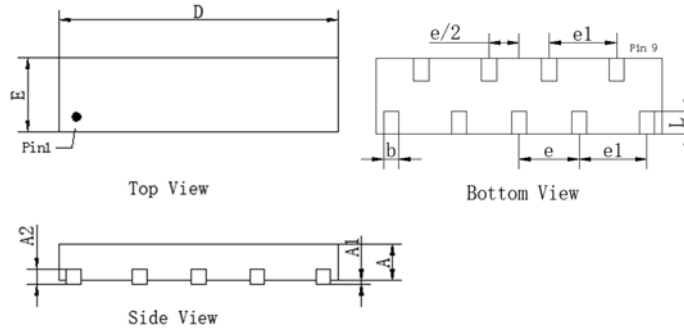
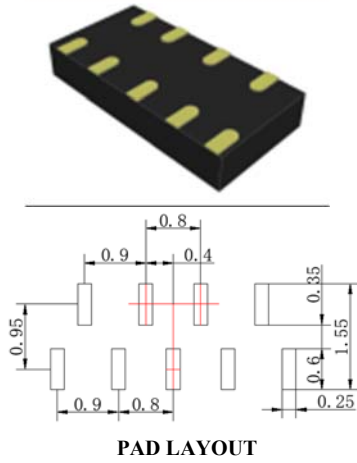

Fig 1

对应型号系列	包装形式	卷盘直径	每盘/盒数量	每箱数量	外包装箱尺寸		
		mm	PCS	PCS	L(mm)	W(mm)	H(mm)
DFN3316-16L封装产品	盘装	178	3,000	120,000	438	438	220

瞬态电压抑制器阵列 ESD/TVS Array

DFN3810-9L封装产品



DIM	Millimeters	
	Min	Max
A	0.45	0.55
A1	0.00	0.05
A2	0.10	0.20
D	3.70	3.90
E	0.90	1.10
b	0.15	0.25
e	0.80REF	
e1	0.90REF	
f	0.20	0.40

Part NO.	Description	工作电压	动作电压	箝位电压	泄漏电流	结电容	极限电流	功能图
		VRWM	VBR	VC@1A	IR	CJ	IPP	Fig
		V	V	V	uA	pF	A	
CLAMP0583M	3.3V, 8-Line, Uni, UltraLow Cap	3.3	4.5	1.5	0.1	0.39		Fig 1

功能图标识

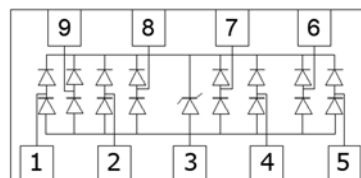
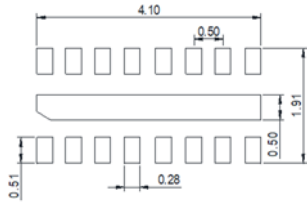
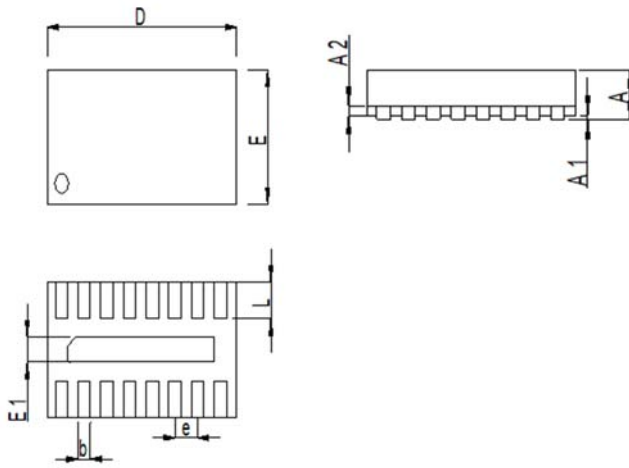

Fig 1

对应型号系列	包装形式	卷盘直径	每盘/盒数量	每箱数量	外包装箱尺寸		
		mm	PCS	PCS	L(mm)	W(mm)	H(mm)
DFN3810-9L封装产品	盘装	178	3,000	120,000	438	438	220

瞬态电压抑制器阵列 ESD/TVS Array

DFN4016-16L封装产品



PAD LAYOUT

DIM	Millimeters	
	Min	Max
A	0.50	0.65
A1	0.00	0.05
A2	0.13BSC	
b	0.20	0.30
D	3.90	4.10
D1	3.10	3.30
E	1.50	1.70
E1	0.25	0.50
e	0.50REF	
l	0.28	0.38

Part NO.	Description	工作电压	动作电压	箝位电压	泄漏电流	结电容	极限电流	功能图
		VRWM	VBR	VC@1A	IR	CJ	IPP	Fig
		V	V	V	uA	pF	A	
WP8401	5V, 2-Line, Uni	5	6	1	100	10		Fig 1

功能图标识

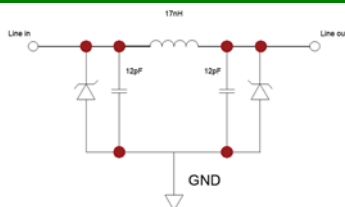
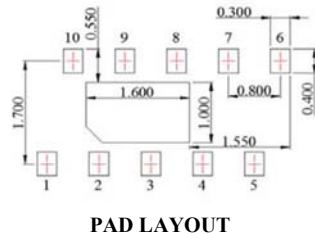
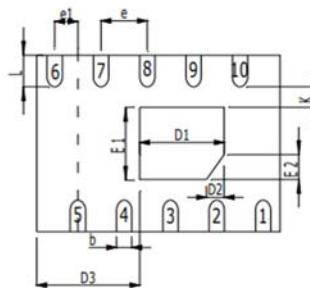
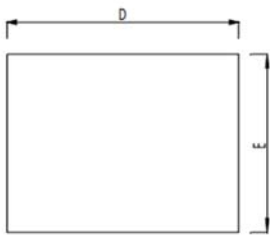
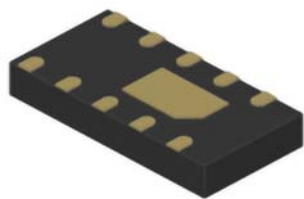

Fig 1

对应型号系列	包装形式	卷盘直径	每盘/盒数量	每箱数量	外包装箱尺寸		
		mm	PCS	PCS	L(mm)	W(mm)	H(mm)
DFN4016-16L封装产品	盘装	178	3,000	120,000	438	438	220

瞬态电压抑制器阵列 ESD/TVS Array

DFN4120-10L封装产品



DIM	Millimeters	
	Min	Max
A	0.45	0.55
A1	0.00	0.05
A3	0.152REF	
D	4.05	4.15
E	1.95	2.05
D1	1.30	1.50
E1	0.70	0.90
D3	1.65	1.85
D2	0.20REF	
E2	0.20REF	
k	0.20 MIN	
b	0.15	0.25
e	0.80TYP	
e1	0.35	0.45
L	0.25	0.35

Part NO.	Description	工作电压	动作电压	箝位电压	泄漏电流	结电容	极限电流	功能图
		VRWM	VBR	VC@1A	IR	CJ	IPP	Fig
		V	V	V	uA	pF	A	
CLAMP0566P	5V, 6-Line, Bi, UltraLow Cap	5	6	27	1	0.5	3	Fig 1
CLAMP0566PB	5V, 6-Line, Bi, UltraLow Cap	5	6	27	1	0.3	3	Fig 1

功能图标识

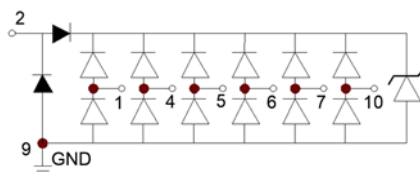
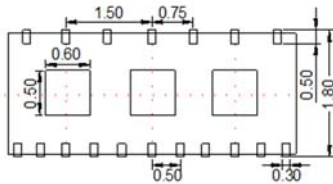
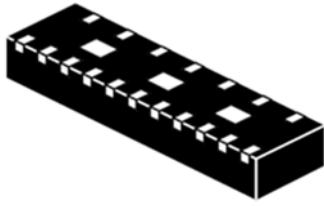

Fig 1

对应型号系列	包装形式	卷盘直径	每盘/盒数量	每箱数量	外包装箱尺寸		
		mm	PCS	PCS	L(mm)	W(mm)	H(mm)
DFN4120-10L封装产品	盘装	178	3,000	120,000	438	438	220

瞬态电压抑制器阵列 ESD/TVS Array

DFN5515-18L封装产品



PAD LAYOUT

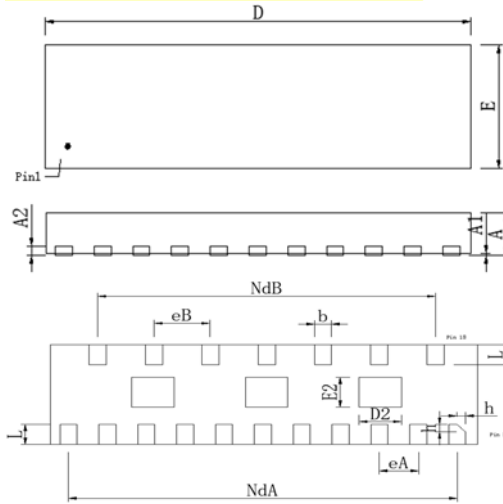

DIM	Millimeters	
	Min	Max
A	0.45	0.55
A1	0.00	0.05
b	0.15	0.25
c	0.10	0.20
D	5.45	5.55
D2	0.45	0.55
E	1.45	1.55
E2	0.35	0.45
L	0.20	0.40
h	0.05	0.15
eA	0.50BSC	
eB	0.75BSC	
NdA	5.00BSC	
NdB	4.50BSC	

Part NO.	Description	工作电压	动作电压	箝位电压	泄漏电流	结电容	极限电流	功能图
		VRWM	VBR	VC@1A	IR	CJ	IPP	Fig
		V	V	V	uA	pF	A	
WPE7008M	5.5V, 8-Line, Bi, UltraLow Cap	5.5	9	8.9	0.1	0.15		Fig 1

功能图标识

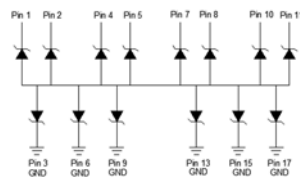
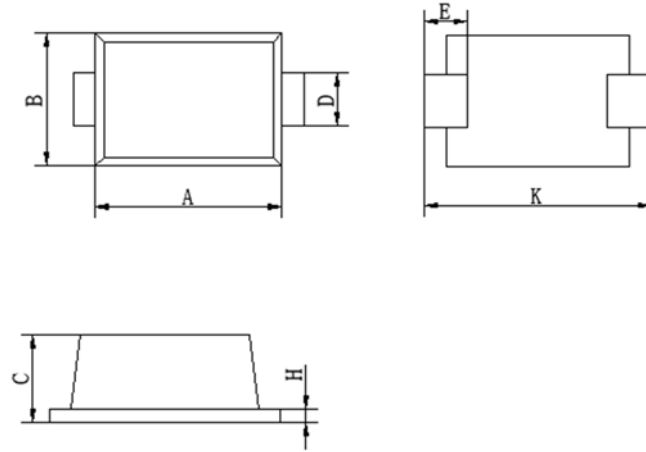
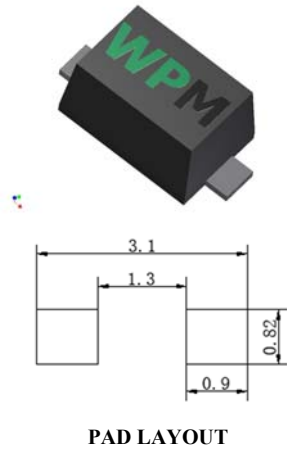

Fig 1

对应型号系列	包装形式	卷盘直径	每盘/盒数量	每箱数量	外包装箱尺寸		
		mm	PCS	PCS	L(mm)	W(mm)	H(mm)
DFN5515-18L封装产品	盘装	178	3,000	120,000	438	438	220

瞬态电压抑制器阵列 ESD/TVS Array

SOD-123FL封装产品



DIM	Millimeters	
	Min	Max
A	2.60	3.00
B	1.60	2.00
C	0.95	1.35
D	0.80	1.20
E	0.30	0.90
H	0.10	0.30
K	3.45	3.95

Part NO.	Description	工作电压	动作电压	箝位电压	泄漏电流	结电容	极限电流	功能图
		VRWM	VBR	VC@1A	IR	CJ	IPP	Fig
		V	V	V	uA	pF	A	
PD24CD1MF	24V, 1-Line, Bi	24	26.1	31	5	300	250	Fig 2
WPT07CD1MF	7V, 1-Line, Bi	7	8.7	16@200	5	800	200	Fig 2
WPT12CD1MF	12V, 1-Line, Bi	12	14.3	30@300	5	500	300	Fig 2
WPT15CD1MF	15V, 1-Line, Bi	15	16.7	27@350	5	300	350	Fig 2
WPT18CD1MF	18V, 1-Line, Bi	18	21	30@150	5	700	150	Fig 2
WPT24CD1MF	24V, 1-Line, Bi	24	26.1	31@250	5	300	250	Fig 2
WPT5V0D1MF	5V, 1-Line, Uni	5	6.4	9.2@110	1	1650	110	Fig 1
WPT07VD1MF	7V, 1-Line, Uni	7	8.7	12.5@200	1	1700	250	Fig 1
WPT12VD1MF	12V, 1-Line, Uni	12	15	22@110	1	750	150	Fig 1
WPT24VD1MF	24V, 1-Line, Uni	24	27.1	30@250	1	650	250	Fig 1

功能图标识

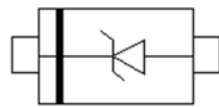

Fig 1

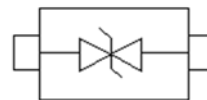
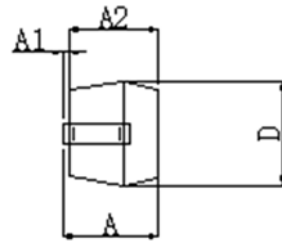
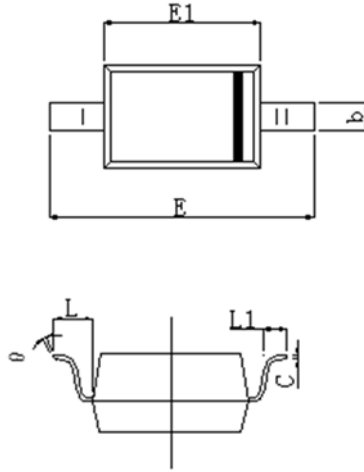
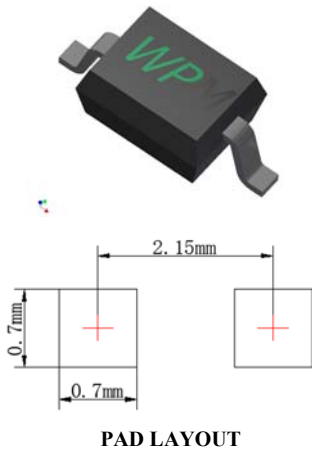

Fig 2

对应型号系列	包装形式	卷盘直径	每盘/盒数量	每箱数量	外包装箱尺寸		
		mm	PCS	PCS	L(mm)	W(mm)	H(mm)
SOD-123FL封装产品	盘装	178	3,000	120,000	438	438	220

瞬态电压抑制器阵列 ESD/TVS Array

SOD-323封装产品



DIM	Millimeters	
	Min	Max
A	1.10MAX	
A1	0.00	0.10
A2	0.80	0.90
b	0.25	0.35
c	0.80	0.15
D	1.20	1.40
E1	1.60	1.80
E	2.50	2.70
L	0.475REF	
L1	0.25	0.40

Part NO.	Description	工作电压	动作电压	箝位电压	泄漏电流	结电容	极限电流	功能图
		VRWM	VBR	VC@1A	IR	CJ	IPP	Fig
		V	V	V	uA	pF	A	
GBLC03C	3V, 1-Line, Bi	3	5.0	7.5	5	1.5	20	Fig 3
GBLC05C	5V, 1-Line, Bi	5	6	9.8	1	1.5	17	Fig 3
GBLC08C	8V, 1-Line, Bi	8	8.5	13.6	1	1.5	15	Fig 3
GBLC12C	12V, 1-Line, Bi	12	13.3	17.8	1	1.5	11	Fig 3
GBLC15C	15V, 1-Line, Bi	15	16.7	23.5	1	1.5	10	Fig 3
GBLC24C	24V, 1-Line, Bi	24	26.7	38	1	1.5	6	Fig 3
GBLC03CI	3V, 1-Line, Bi, UltraLow Cap	3	4	7.5	5	0.8	25	Fig 3
GBLC05CI	5V, 1-Line, Bi, UltraLow Cap	5	6	9.8	2	0.8	22	Fig 3
GBLC08CI	8V, 1-Line, Bi, UltraLow Cap	8	8.5	13.6	1	0.8	10	Fig 3
GBLC12CI	12V, 1-Line, Bi, UltraLow Cap	12	13.3	19	1	0.8	8	Fig 3
GBLC15CI	15V, 1-Line, Bi, UltraLow Cap	15	16.7	24	1	0.8	8	Fig 3
GBLC24CI	24V, 1-Line, Bi, UltraLow Cap	24	26.7	43	1	0.8	6	Fig 3
WPE4V5D3AT1	4.5V, 1-Line, Uni	4.5	5	10@50	1	300		Fig 1
WPE05VD3AT1	5V, 1-Line, Uni	5	6	7	1	294	29	Fig 1
WPE12VD3AT1	12V, 1-Line, Uni	12	13.1	15	1	122	20	Fig 1
WPE15VD3AT1	15V, 1-Line, Uni	15	16.7	19	1	92	14	Fig 1
WPE24VD3AT1	24V, 1-Line, Uni	24	26.7	35	1	61	7	Fig 1

功能图标识

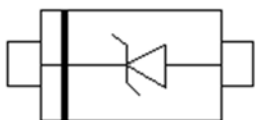

Fig 1

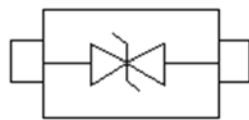

Fig 2

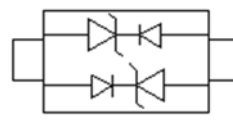

Fig 3

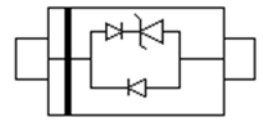
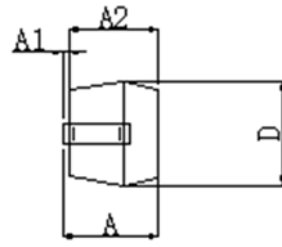
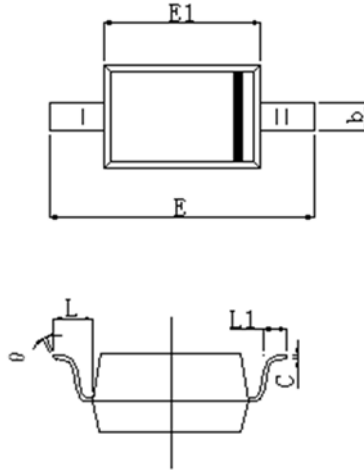
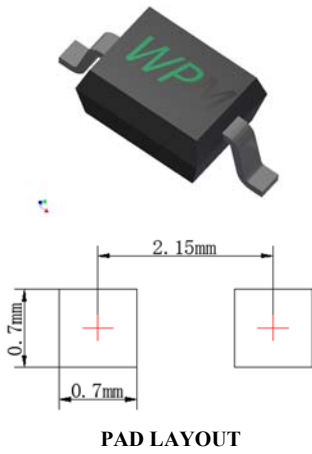

Fig 4

对应型号系列	包装形式	卷盘直径	每盘/盒数量	每箱数量	外包装箱尺寸		
		mm	PCS	PCS	L(mm)	W(mm)	H(mm)
SOD-323封装产品	盘装	178	3,000	120,000	438	438	220

瞬态电压抑制器阵列 ESD/TVS Array

SOD-323封装产品



DIM	Millimeters	
	Min	Max
A	1.10MAX	
A1	0.00	0.10
A2	0.80	0.90
b	0.25	0.35
c	0.80	0.15
D	1.20	1.40
E1	1.60	1.80
E	2.50	2.70
L	0.475REF	
L1	0.25	0.40

Part NO.	Description	工作电压	动作电压	箝位电压	泄漏电流	结电容	极限电流	功能图
		VRWM	VBR	VC@1A	IR	CJ	IPP	Fig
		V	V	V	uA	pF	A	
WPE3V3D3BB	3.3V, 1-Line, Bi	3.3	4	7.8	20	175	25	Fig 2
WPE5V0D3BB	5V, 1-Line, Bi	5	6.3	9.8	5	175	25	Fig 2
WPE12VD3BB	12V, 1-Line, Bi	12	13.3	19	1	75	12	Fig 2
WPE15VD3BB	15V, 1-Line, Bi	15	16.7	24	1	34	12	Fig 2
WPE18VD3BB	18V, 1-Line, Bi	18	20	29	1	26	8	Fig 2
WPE24VD3BB	24V, 1-Line, Bi	24	26.1	43	1	19	5	Fig 2
WPE5V0D3BL1	5V, 1-Line, Bi	5	5.6	9.5	1	7		Fig 2
WPE5V0D3BL2	5V, 1-Line, Bi	5	5.6	9.5	1	3.5		Fig 2
WPE3V3D3BLA	3.3V, 1-Line, Bi	3.3	4	7.8	20	100	17	Fig 2
WPE5V0D3BLA	5V, 1-Line, Bi	5	6	8	5	75	20	Fig 2
WPE8V0D3BLA	8V, 1-Line, Bi	8	8	9	1	54	18	Fig 3
WPE12VD3BLA	12V, 1-Line, Bi	12	13.3	19	1	30	8	Fig 2
WPE15VD3BLA	15V, 1-Line, Bi	15	16.7	24	1	22	5	Fig 2
WPE18VD3BLA	18V, 1-Line, Bi	18	20	29	1	20	5	Fig 2
WPE24VD3BLA	24V, 1-Line, Bi	24	26.1	43	1	12	3	Fig 2
WPE36VD3BLA	36V, 1-Line, Bi	36	40	60	1	30	2.5	Fig 2
WPE12VD3BLB	12V, 1-Line, Bi	12	13.3	19	1	18	6	Fig 2

功能图标识

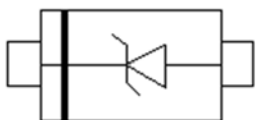

Fig 1

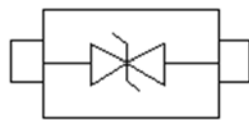

Fig 2

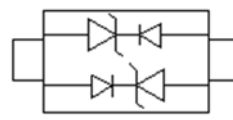

Fig 3

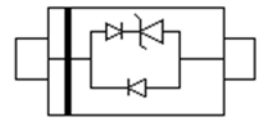
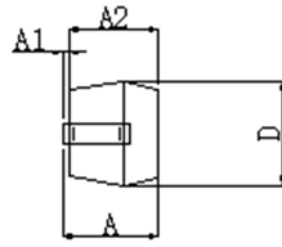
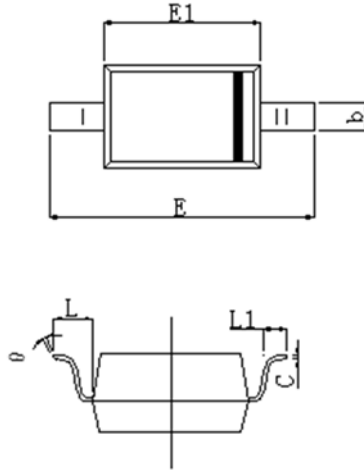
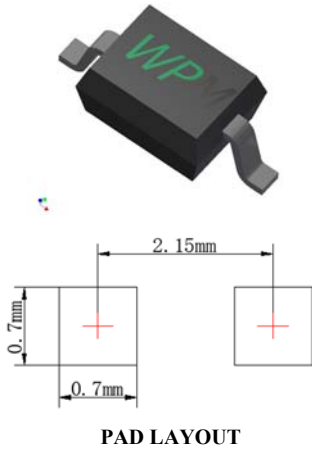

Fig 4

对应型号系列	包装形式	卷盘直径	每盘/盒数量	每箱数量	外包装箱尺寸		
		mm	PCS	PCS	L(mm)	W(mm)	H(mm)
SOD-323封装产品	盘装	178	3,000	120,000	438	438	220

瞬态电压抑制器阵列 ESD/TVS Array

SOD-323封装产品



DIM	Millimeters	
	Min	Max
A	1.10MAX	
A1	0.00	0.10
A2	0.80	0.90
b	0.25	0.35
c	0.80	0.15
D	1.20	1.40
E1	1.60	1.80
E	2.50	2.70
L	0.475REF	
L1	0.25	0.40

Part NO.	Description	工作电压	动作电压	箝位电压	泄漏电流	结电容	极限电流	功能图
		VRWM	VBR	VC@1A	IR	CJ	IPP	Fig
		V	V	V	uA	pF	A	
WPE15VD3BLB	15V, 1-Line, Bi	15	16.7	24	1	16	6	Fig 2
WPE18VD3BLB	18V, 1-Line, Bi	18	19.8	32	1	13	4	Fig 2
WPE24VD3BLB	24V, 1-Line, Bi	24	26.5	40	1	8	3	Fig 2
WPE05VD3AUL	5V, 1-Line, Uni, UltraLow Cap	5	6	9.8	1	0.35		Fig 4
WPE3V3D3UW	3.3V, 1-Line, Bi, UltraLow Cap	3.3	4	5	1	0.8	20	Fig 3
WPE3V3D3ULA	3.3V, 1-Line, Bi, UltraLow Cap	3.3	4	8.5	5	0.8	20	Fig 3
WPE5V0D3ULA	5V, 1-Line, Bi, UltraLow Cap	5	6	9.8	1	0.8	17	Fig 3
WPE8V0D3ULA	8V, 1-Line, Bi, UltraLow Cap	8	8.5	13.6	1	0.8	15	Fig 3
WPE12VD3ULA	12V, 1-Line, Bi, UltraLow Cap	12	13.3	17.8	1	0.8	11	Fig 3
WPE15VD3ULA	15V, 1-Line, Bi, UltraLow Cap	15	16.7	23.5	1	0.8	10	Fig 3
WPE24VD3ULA	24V, 1-Line, Bi, UltraLow Cap	24	26.7	38	1	0.8	6	Fig 3
WPE12VD3ULB	12V, 1-Line, Bi, UltraLow Cap	12	13.3	15.8	1	0.8	17	Fig 3
WPE5V0D3ULF	5V, 1-Line, Bi, UltraLow Cap	5	6		1	0.3		Fig 3
WPT4V5D3AT2	4.5V, 1-Line, Uni	4.5	5	12.3	1	527		Fig 1
WPT4V5D3BT1	4.5V, 1-Line, Bi	4.5	5	8@50	1	400		Fig 2
WPT5V0D3BT1	5V, 1-Line, Bi	5	5.3	13	1	400		Fig 2

功能图标识

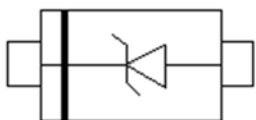

Fig 1

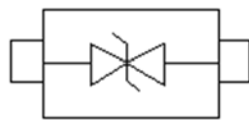

Fig 2

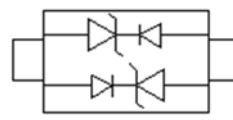

Fig 3

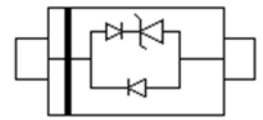
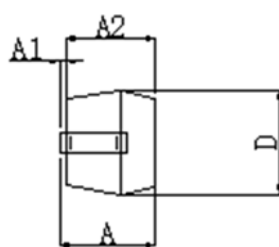
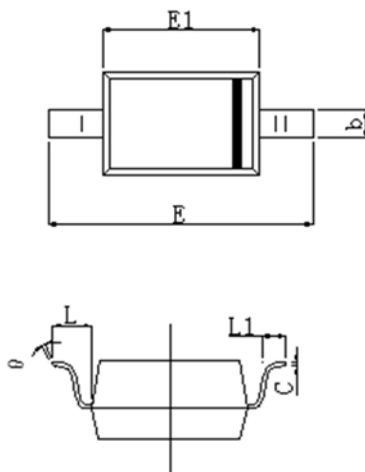
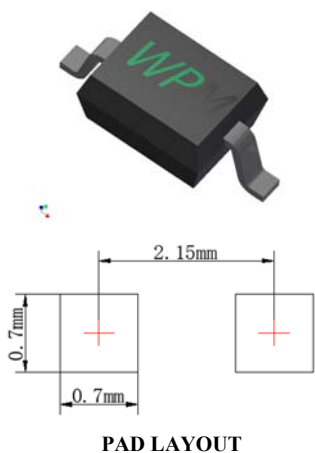

Fig 4

对应型号系列	包装形式	卷盘直径	每盘/盒数量	每箱数量	外包装箱尺寸		
		mm	PCS	PCS	L(mm)	W(mm)	H(mm)
SOD-323封装产品	盘装	178	3,000	120,000	438	438	220

瞬态电压抑制器阵列 ESD/TVS Array

SOD-323封装产品



DIM	Millimeters	
	Min	Max
A	1.10MAX	
A1	0.00	0.10
A2	0.80	0.90
b	0.25	0.35
c	0.80	0.15
D	1.20	1.40
E1	1.60	1.80
E	2.50	2.70
L	0.475REF	
L1	0.25	0.40

Part NO.	Description	工作电压	动作电压	箝位电压	泄漏电流	结电容	极限电流	功能图
		VRWM	VBR	VC@1A	IR	CJ	IPP	Fig
		V	V	V	uA	pF	A	
WPT5V0D3MF	5V, 1-Line, Uni	5	6	15@100	1	1100	130	Fig 1
WPT7V0D3MF	7V, 1-Line, Uni, UltraLow Cap	7	7.8	17@100	1	800	130	Fig 1
WPT12V0D3MF	12V, 1-Line, Uni, UltraLow Cap	12	13	30@70	1	400	80	Fig 1
WPT15V0D3MF	15V, 1-Line, Uni, UltraLow Cap	15	16.7	30@50	1	400	65	Fig 1
WPT24V0D3MF	24V, 1-Line, Uni, UltraLow Cap	24	25.6	38@20	1	200	30	Fig 1
SD03	3.3V, 1-Line, Uni	3.3	4	7.6	20	260		Fig 1
SD05	5V, 1-Line, Uni	5	6	9.6	1	240		Fig 1
SD12	12V, 1-Line, Uni	12	13.6	19	1	55		Fig 1
SD15	15V, 1-Line, Uni	15	16.7	24	1	43		Fig 1
SD24	24V, 1-Line, Uni	24	26.7	43	1	27		Fig 1
SD36	36V, 1-Line, Uni	36	40	60	1	27		Fig 1
SD03C	3.3V, 1-Line, Bi	3.3	4	6.5	20	120		Fig 2
SD05C	5V, 1-Line, Bi	5	5.6	9.8	1	135		Fig 2
SD12C	12V, 1-Line, Bi	12	13.3	19	1	45		Fig 2
SD15C	15V, 1-Line, Bi	15	16.7	24	1	45		Fig 2

功能图标识

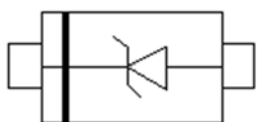

Fig 1

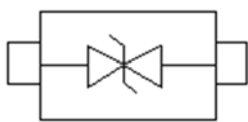

Fig 2

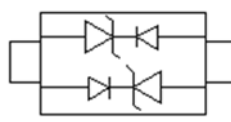

Fig 3

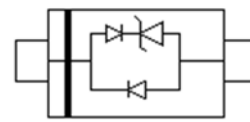
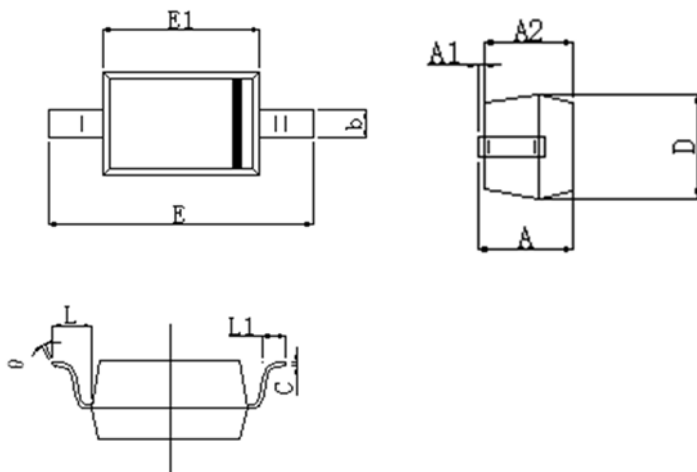
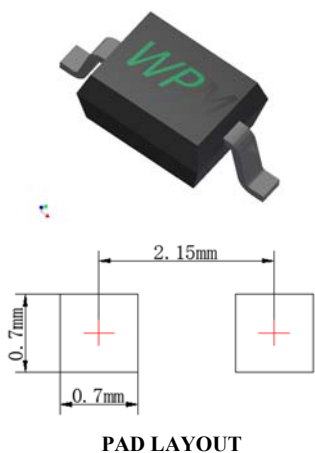

Fig 4

对应型号系列	包装形式	卷盘直径	每盘/盒数量	每箱数量	外包装箱尺寸		
		mm	PCS	PCS	L(mm)	W(mm)	H(mm)
SOD-323封装产品	盘装	178	3,000	120,000	438	438	220

瞬态电压抑制器阵列 ESD/TVS Array

SOD-323封装产品



DIM	Millimeters	
	Min	Max
A	1.10MAX	
A1	0.00	0.10
A2	0.80	0.90
b	0.25	0.35
c	0.80	0.15
D	1.20	1.40
E1	1.60	1.80
E	2.50	2.70
L	0.475REF	
L1	0.25	0.40

Part NO.	Description	工作电压	动作电压	箝位电压	泄漏电流	结电容	极限电流	功能图
		VRWM	VBR	VC@1A	IR	CJ	IPP	Fig
		V	V	V	uA	pF	A	
SD24C	24V, 1-Line, Bi	24	26.7	43	1	35		Fig 2
SD36C	36V, 1-Line, Bi	36	40	60	1	35		Fig 2
SD05LC	5V, 1-Line, Bi	5	5.3	9.8	1	4.5		Fig 2

功能图标识

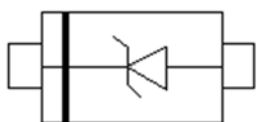

Fig 1

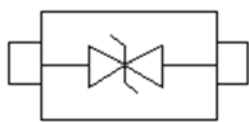

Fig 2

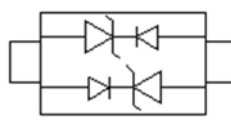

Fig 3

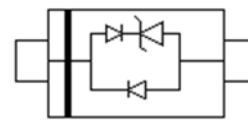
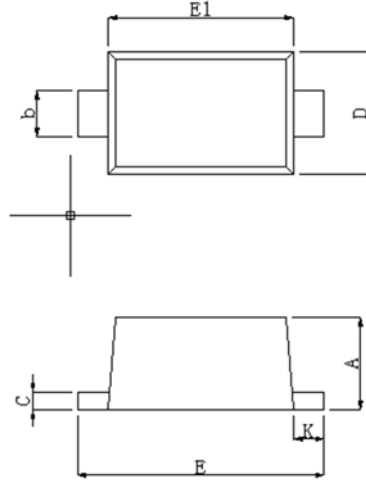
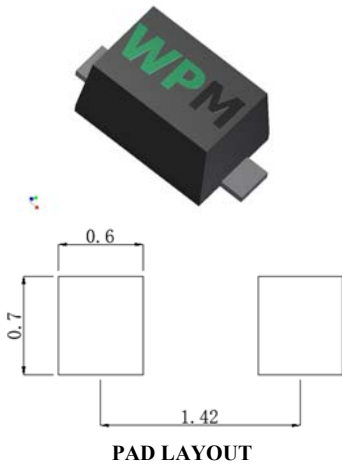

Fig 4

对应型号系列	包装形式	卷盘直径	每盘/盒数量	每箱数量	外包装箱尺寸		
		mm	PCS	PCS	L(mm)	W(mm)	H(mm)
SOD-323封装产品	盘装	178	3,000	120,000	438	438	220

瞬态电压抑制器阵列 ESD/TVS Array

SOD-523封装产品



DIM	Millimeters	
	Min	Max
A	0.51	0.70
b	0.25	0.40
C	0.80	0.15
D	0.75	0.85
E	1.50	1.70
E1	1.10	1.30
K	0.15	0.25

Part NO.	Description	工作电压	动作电压	箝位电压	泄漏电流	结电容	极限电流	功能图
		VRWM	VBR	VC@1A	IR	CJ	IPP	Fig
		V	V	V	uA	pF	A	
ESD5B5CL	5V, 1-Line, Bi	5	5.2	9	1	3		Fig 2
ESD5L5V	5V, 1-Line, Uni, UltraLow Cap	5	6	12	2	0.5		Fig 1
ESD5Z3V3	3.3V, 1-Line, Uni	3.3	4	7.5	20	35		Fig 1
ESD5Z5V	5V, 1-Line, Uni	5	6	9.8	2	36		Fig 1
ESD5Z7V	7V, 1-Line, Uni	7	9	9.2	2	70		Fig 1
ESD5Z12V	12V, 1-Line, Uni	12	13.1	17.8	2	35		Fig 1
ESD5Z15V	15V, 1-Line, Uni	15	16.7	24	2	35		Fig 1
ESD5Z24V	24V, 1-Line, Uni	24	26.7	43	2	30		Fig 1
ESD5Z36V	36V, 1-Line, Uni	36	40	69.5	2	28		Fig 1
ESD5Z36VD1	36V, 1-Line, Uni	36	40	49.3	1	28	3	Fig 1
ESD5G5CL	5V, 1-Line, Bi	5	6	9	1	2.5		Fig 2
ESD5Z3.3C	3.3V, 1-Line, Bi	3.3	4	5.2	0.5	7.5		Fig 2
ESD5Z5C	5V, 1-Line, Bi	5	6	9.8	2	25		Fig 2
ESD5Z5CB	5V, 1-Line, Bi	5	6	10.6	1	7		Fig 2
ESD5Z5CL	5V, 1-Line, Bi	5	5.2	9	1	4.5		Fig 2
WPE5V0D5BL1	5V, 1-Line, Bi	5	6	10	1	5		Fig 2
WPE5V0D5BL2	5V, 1-Line, Bi	5	6	10	1	3.5		Fig 2

功能图标识

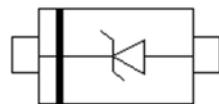

Fig 1

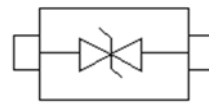
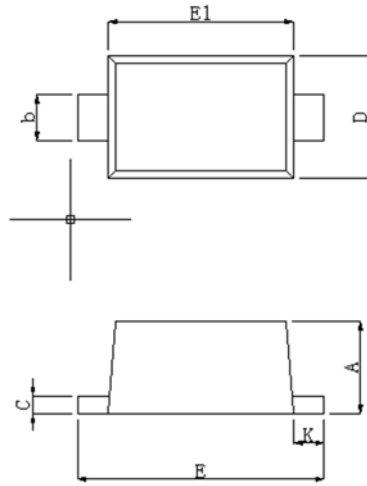
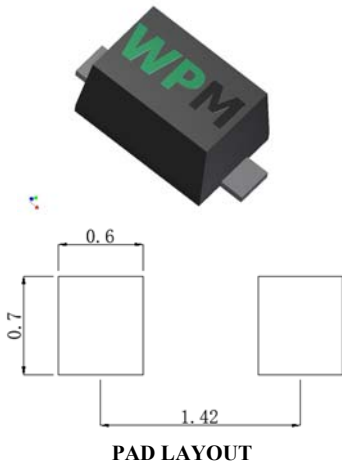

Fig 2

对应型号系列	包装形式	卷盘直径	每盘/盒数量	每箱数量	外包装箱尺寸		
		mm	PCS	PCS	L(mm)	W(mm)	H(mm)
SOD-523封装产品	盘装	178	3,000	120,000	438	438	220

瞬态电压抑制器阵列 ESD/TVS Array

SOD-523封装产品



DIM	Millimeters	
	Min	Max
A	0.51	0.70
b	0.25	0.40
C	0.80	0.15
D	0.75	0.85
E	1.50	1.70
E1	1.10	1.30
K	0.15	0.25

Part NO.	Description	工作电压	动作电压	箝位电压	泄漏电流	结电容	极限电流	功能图
		VRWM	VBR	VC@1A	IR	CJ	IPP	Fig
		V	V	V	uA	pF	A	
WPE03CD52BL	3.3V, 1-Line, Bi	3.3	3.8	5	0.1	52		Fig 2

功能图标识

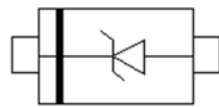

Fig 1

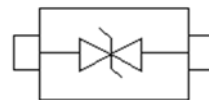
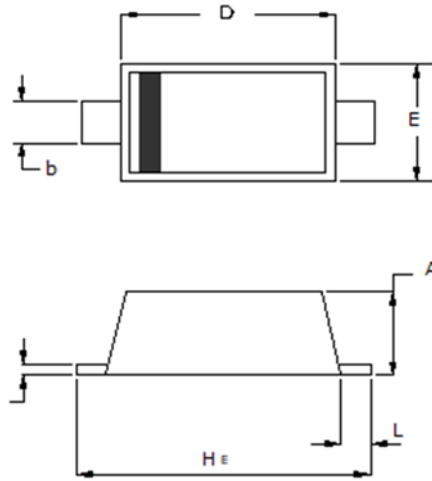
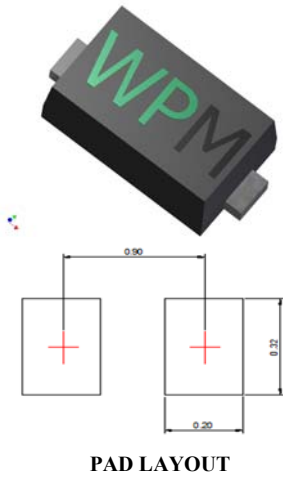

Fig 2

对应型号系列	包装形式	卷盘直径	每盘/盒数量	每箱数量	外包装箱尺寸		
		mm	PCS	PCS	L(mm)	W(mm)	H(mm)
SOD-523封装产品	盘装	178	3,000	120,000	438	438	220

瞬态电压抑制器阵列 ESD/TVS Array

SOD-923封装产品



DIM	Millimeters	
	Min	Max
A	0.35	0.43
B	0.17	0.27
C	0.07	0.17
D	0.75	0.85
E	0.55	0.65
He	0.90	1.10
L	0.15BCS	

Part NO.	Description	工作电压	动作电压	箝位电压	泄漏电流	结电容	极限电流	功能图
		VRWM	VBR	VC@1A	IR	CJ	IPP	Fig
		V	V	V	uA	pF	A	
ESD9D5C	5V, 1-Line, Bi	5	6	9.8	2	12		Fig 1

功能图标识

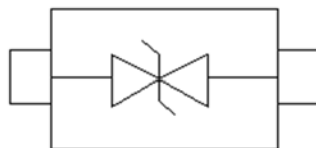
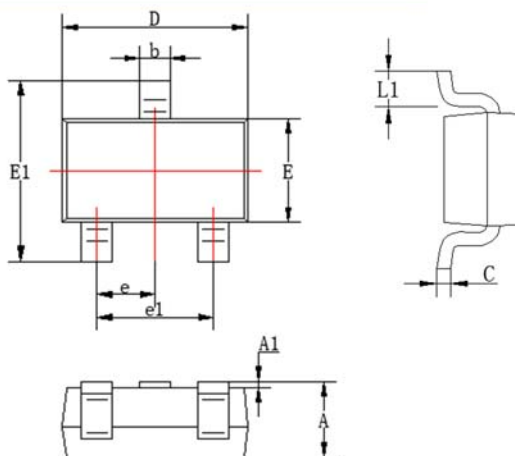
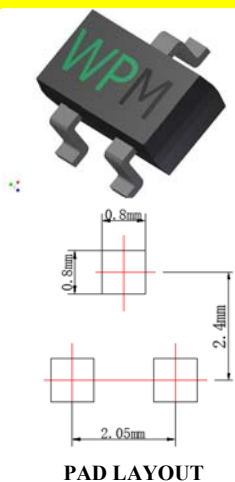

Fig 1

对应型号系列	包装形式	卷盘直径	每盘/盒数量	每箱数量	外包装箱尺寸		
		mm	PCS	PCS	L(mm)	W(mm)	H(mm)
SOD-923封装产品	盘装	178	3,000	120,000	438	438	220

瞬态电压抑制器阵列 ESD/TVS Array

SOT-23封装产品



DIM	Millimeters	
	Min	Max
A	0.89	1.20
A1	0.00	0.10
b	0.30	0.50
C	0.80	0.19
D	2.80	3.04
E	1.20	1.40
E1	2.20	2.60
e	0.89	1.02
e1	1.78	2.04
L1	0.20min	

Part NO.	Description	工作电压	动作电压	箝位电压	泄漏电流	结电容	极限电流	功能图
		VRWM	VBR	VC@1A	IR	CJ	IPP	Fig
		V	V	V	uA	pF	A	
SOT03C	3V, 2-Line, Uni	3	4	7.8	20	53	6	Fig 2
SOT05C	5V, 2-Line, Uni	5	6	9.8	1	45	6	Fig 2
SOT12C	12V, 2-Line, Uni	12	13.3	19	1	40	10	Fig 2
SOT15C	15V, 2-Line, Uni	15	16.7	24	1	32	7	Fig 2
SOT24C	24V, 2-Line, Uni	24	26.7	43	1	45	5	Fig 2
SOT36C	36V, 2-Line, Uni	36	40	60	1	40	3	Fig 2
SOT15CD	15V, 2-Line, Uni	15	16.7	24	1	70	10	Fig 2
SOT05CD	5V, 2-Line, Uni	5	6	9.8	1	150	17	Fig 2
SOT05LC	5V, 1-Line, Bi	5	6	9.8	1	1.5	10	Fig 1
SOT12LC	12V, 1-Line, Bi	12	13.3	19	1	1.5	6	Fig 1
SOT15LC	15V, 1-Line, Bi	15	16.7	24	1	1.5	5	Fig 1
SOT24LC	24V, 1-Line, Bi	24	26.7	43	1	1.5	3	Fig 1
SOT05ULC	5V, 2-Line, Bi, UltraLow Cap	5	6	8.8	1	0.25	4	Fig 2
SLVU2.8	2.8V, 1-Line, Bi	2.8	2.8 3	3.9 8.5	1	3		Fig 5
SM712	7V, 2-Line, Bi	7	7.5	10	20	50		Fig 4
	12V, 2-Line, Bi	12	13.3	18	1	50		Fig 4

功能图标识

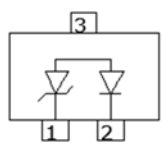

Fig 1

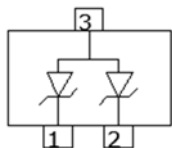

Fig 2

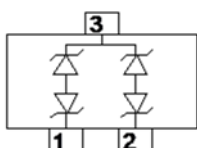

Fig 3

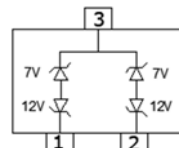

Fig 4

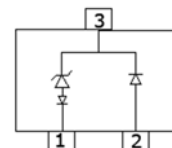
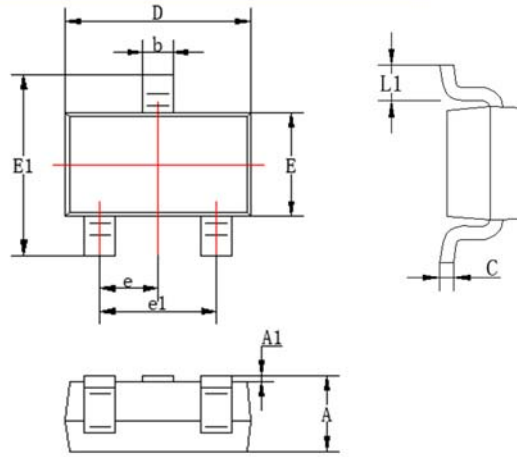
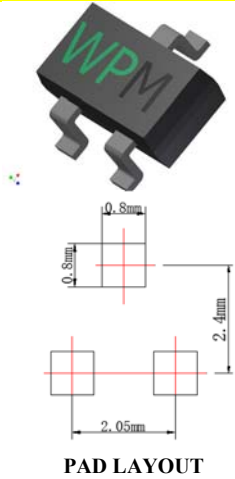

Fig 5

对应型号系列	包装形式	卷盘直径	每盘/盒数量	每箱数量	外包装箱尺寸		
		mm	PCS	PCS	L(mm)	W(mm)	H(mm)
SOT-23封装产品	盘装	178	3,000	120,000	438	438	220

瞬态电压抑制器阵列 ESD/TVS Array

SOT-23封装产品



DIM	Millimeters	
	Min	Max
A	0.89	1.20
A1	0.00	0.10
b	0.30	0.50
C	0.80	0.19
D	2.80	3.04
E	1.20	1.40
E1	2.20	2.60
e	0.89	1.02
e1	1.78	2.04
L1	0.20min	

Part NO.	Description	工作电压	动作电压	箝位电压	泄漏电流	结电容	极限电流	功能图
		VRWM	VBR	VC@1A	IR	CJ	IPP	Fig
		V	V	V	uA	pF	A	
WPE03CT23BB	3.3V, 2-Line, Bi	3.3	4	4.6	1	87	25	Fig 3
WPE03CT23BL	3.3V, 2-Line, Bi	3.3	4	5.4	1	15		Fig 3
WPE05CT23BL	5V, 2-Line, Bi	5	5.8	7.5	1	14	6	Fig 3
WPE12CT23BL	12V, 2-Line, Bi	12	13.3	19	1	16	7	Fig 3
WPE15CT23BL	15V, 2-Line, Bi	15	16.7	24	1	15	15	Fig 3
WPE24CT23BL	24V, 2-Line, Bi	24	26.7	43	1	11	3	Fig 3
WPE03CT23BLA	3.3V, 2-Line, Bi	3.3	4	6.5	10	135	17	Fig 3
WPE03DT23ULA	3.3V, 2-Line, Bi	3.3	4	5.1	50	5		Fig 3
WPE05DT23ULA	5V, 2-Line, Bi	5	6.4	9.8	5	1.2	17	Fig 3
WPE05VT23UL	5V, 2-Line, Uni, UltraLow Cap	5	6	8.6	1	0.45		Fig 2

功能图标识

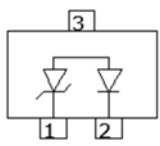

Fig 1

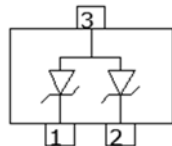

Fig 2

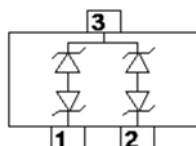

Fig 3

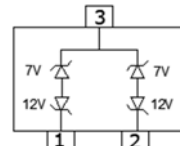

Fig 4

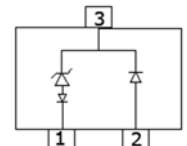
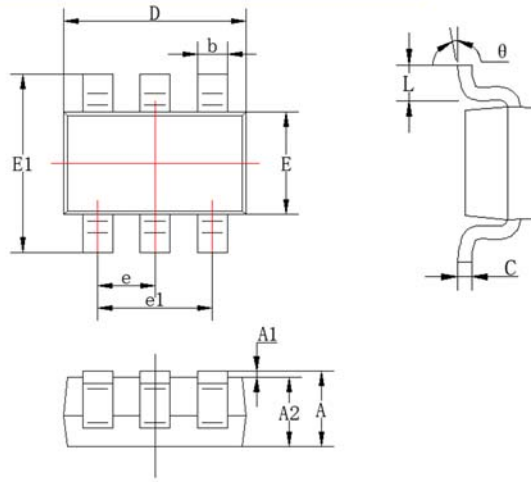
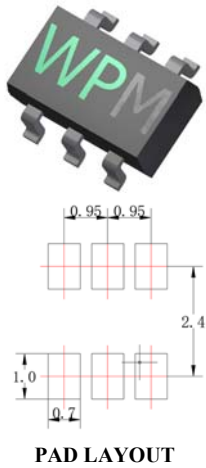

Fig 5

对应型号系列	包装形式	卷盘直径	每盘/盒数量	每箱数量	外包装箱尺寸		
		mm	PCS	PCS	L(mm)	W(mm)	H(mm)
SOT-23封装产品	盘装	178	3,000	120,000	438	438	220

瞬态电压抑制器阵列 ESD/TVS Array

SOT23-6L封装产品



DIM	Millimeters	
	Min	Max
A	1.05	1.25
A1	0.00	0.10
A2	1.05	1.15
b	0.30	0.50
c	0.10	0.20
D	2.82	3.02
E	1.50	1.70
E1	2.65	2.95
e	0.95BSC	
e1	1.80	2.00
L	0.30	0.60

Part NO.	Description	工作电压	动作电压	箝位电压	泄漏电流	结电容	极限电流	功能图
		VRWM V	VBR V	VC@1A V	IR uA	CJ pF	IPP A	Fig
CLAMP0502D	5V, 4-Line, Uni, UltraLow Cap	5	6	12.5	1	0.55	4.5	Fig 4
CLAMP3304DL2HP	3.3V, 4-Line, Uni	3.3	4	5.9	1	1	18	Fig 2
CLAMP0504DL2	5V, 4-Line, Uni, UltraLow Cap	5	6	8.7	1	0.45		Fig 2
CLAMP0504D	5V, 4-Line, Uni, UltraLow Cap	5	6	15.5	1	0.9	5	Fig 2
CLAMP0504DH	5V, 4-Line, Uni, UltraLow Cap	5	6	9	1	0.6	6	Fig 2
CLAMP0504DL	5V, 4-Line, Uni, UltraLow Cap	5	6	15.5	1	0.65		Fig 2
CLAMP0504DP	5.5V, 4-Line, Uni	5.5	6	5.6	1	1.05	15	Fig 2
CLAMP0504DT	5V, 4-Line, Uni, UltraLow Cap	5	6	9	1	0.35	5	Fig 2
CLAMP0504DL1HP	5V, 4-Line, Uni	5	6	10	0.1	2.36	25	Fig 2
CLAMP0504DPCR	3.3V, 4-Line, Uni, UltraLow Cap	3.3	4	5.8	1	0.65	4	Fig 2
CLAMP0504DL2HP	5V, 4-Line, Uni	5	6	12.7	1	2.1	20	Fig 2
CLAMP0514DT	5V, 4-Line, Uni, UltraLow Cap	5	6	9	1	0.55	6	Fig 3
WPE0504C-T236	5V, 4-Line, Uni	5	5.6	9.8	1	4.5		Fig 4
SMS05	5V, 4-Line, Uni	5	6	10	0.1	15	2.5	Fig 6
SMS05C	5V, 4-Line, Uni	5	6	10	0.1	15	2.5	Fig 1
SMS24C	24V, 4-Line, Uni	24	26.7	45	1	45.6	4	Fig 1
SRV05-4	5V, 4-Line, Uni	5	6	7.2	1	2.5	4	Fig 2

功能图标识

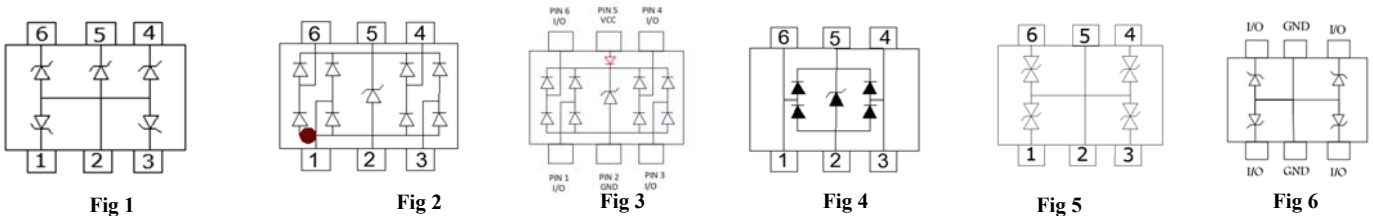

对应型号系列	包装形式	卷盘直径	每盘/盒数量	每箱数量	外包装箱尺寸		
		mm	PCS	PCS	L(mm)	W(mm)	H(mm)
SOT23-6L封装产品	盘装	178	3,000	120,000	438	438	220

瞬态电压抑制器阵列 ESD/TVS Array

SOT23-6L封装产品

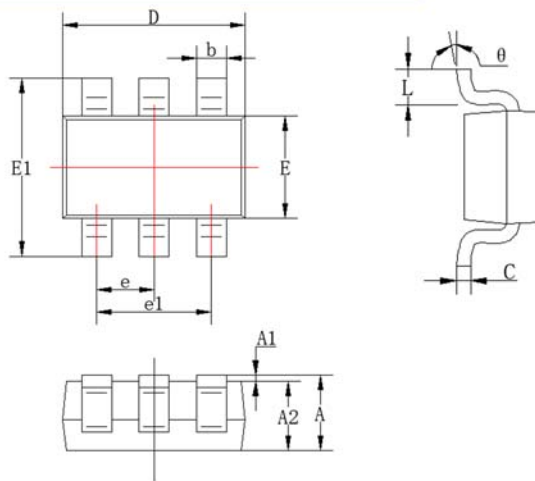
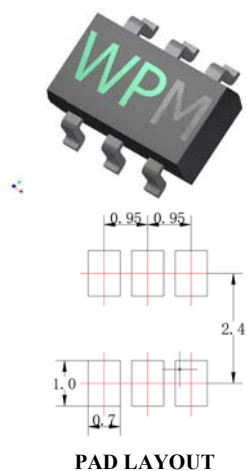

DIM	Millimeters	
	Min	Max
A	1.05	1.25
A1	0.00	0.10
A2	1.05	1.15
b	0.30	0.50
c	0.10	0.20
D	2.82	3.02
E	1.50	1.70
E1	2.65	2.95
e	0.95BSC	
e1	1.80	2.00
L	0.30	0.60

Part NO.	Description	工作电压	动作电压	箝位电压	泄漏电流	结电容	极限电流	功能图
		VRWM V	VBR V	VC@1A V	IR uA	CJ pF	IPP A	Fig
SRV05-4C	5V, 4-Line, Uni	5	6	12	1	3.5	20	Fig 2
SRV05-4LC	5V, 4-Line, Uni	5	6	12.7	1	1.9	12	Fig 2
CLAMP0514DCR	5V, 4-Line, Uni, UltraLow Cap	5	3.3	9	0.1	0.6	10	Fig 3

功能图标识

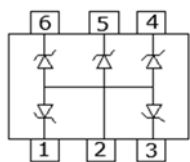

Fig 1

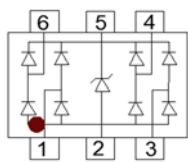

Fig 2

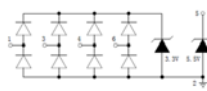

Fig 3

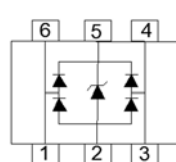

Fig 4

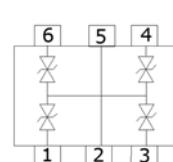

Fig 5

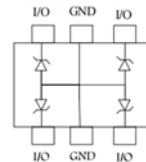
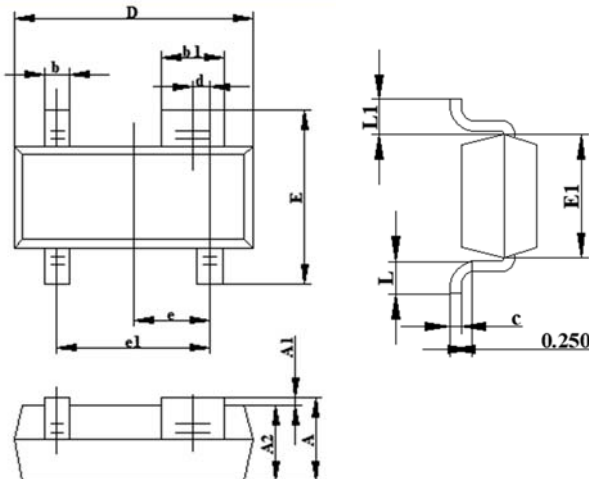
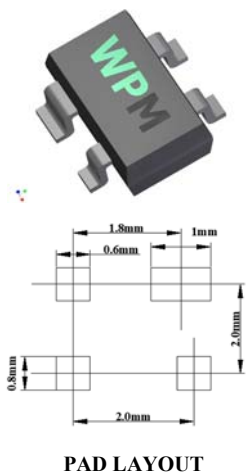

Fig 6

对应型号系列	包装形式	卷盘直径	每盘/盒数量	每箱数量	外包装箱尺寸		
		mm	PCS	PCS	L(mm)	W(mm)	H(mm)
SOT23-6L封装产品	盘装	178	3,000	120,000	438	438	220

瞬态电压抑制器阵列 ESD/TVS Array

SOT-143封装产品



DIM	Millimeters	
	Min	Max
A	0.90	1.15
A1	0.00	0.10
A2	0.90	1.05
b	0.30	0.50
b1	0.75	0.90
c	0.08	0.15
D	2.80	3.00
d	0.20TYP	
E	1.20	1.40
E1	2.25	2.55
e	0.95TYP	
e1	1.80	2.00
L	0.55REF	
L1	0.30	0.50

Part NO.	Description	工作电压	动作电压	箝位电压	泄漏电流	结电容	极限电流	功能图
		VRWM	VBR	VC@1A	IR	CJ	IPP	Fig
		V	V	V	uA	pF	A	
SR05LC	5V, 4-Line, Uni, UltraLow Cap	5	6	9.8	1	0.9	5	Fig 1
SR70	70V,4-Line,Uni	70	70	1.1	2	5	25	Fig 2

功能图标识

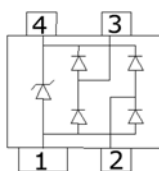

Fig 1

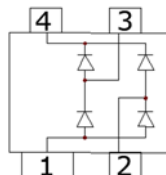
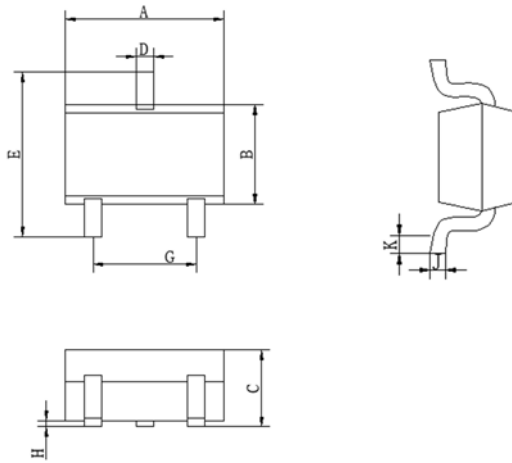
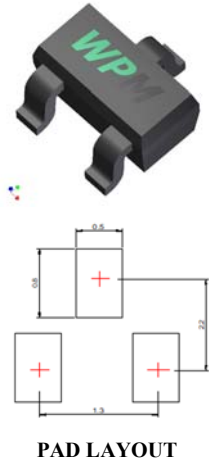

Fig 2

对应型号系列	包装形式	卷盘直径	每盘/盒数量	每箱数量	外包装箱尺寸		
		mm	PCS	PCS	L(mm)	W(mm)	H(mm)
SOT-143封装产品	盘装	178	3,000	120,000	438	438	220

瞬态电压抑制器阵列 ESD/TVS Array

SOT-323封装产品



DIM	Millimeters	
	Min	Max
A	1.80	2.20
B	1.15	1.35
C	0.90	1.10
D	0.10	0.35
G	1.20	1.40
H	0.00	0.10
J	0.08	0.25
K	0.15	0.40
L	0.65TYP	
E	2.15	2.45

Part NO.	Description	工作电压	动作电压	箝位电压	泄漏电流	结电容	极限电流	功能图
		VRWM	VBR	VC@1A	IR	CJ	IPP	Fig
		V	V	V	uA	pF	A	
WPE24CT32BL	24V, 1-Line, Bi	24	26.5	39	0.01	18	3	Fig 1

功能图标识

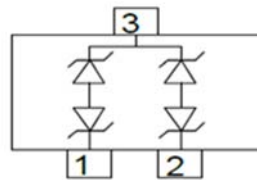
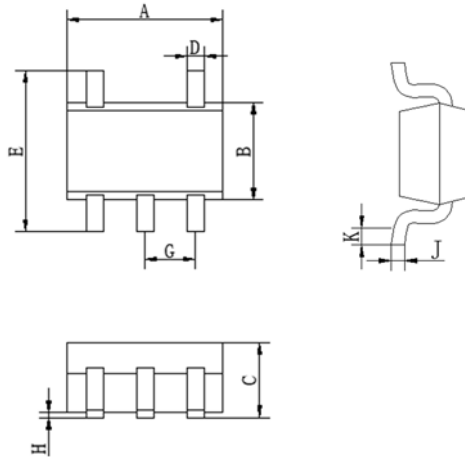
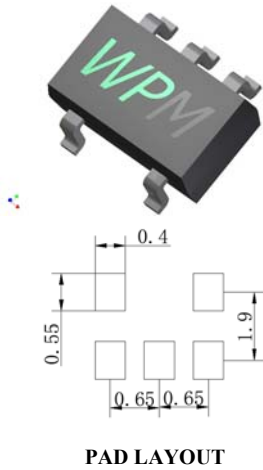

Fig 1

对应型号系列	包装形式	卷盘直径	每盘/盒数量	每箱数量	外包装箱尺寸		
		mm	PCS	PCS	L(mm)	W(mm)	H(mm)
SOT-323封装产品	盘装	178	3,000	120,000	438	438	220

瞬态电压抑制器阵列 ESD/TVS Array

SOT-353封装产品



DIM	Millimeters	
	Min	Max
A	1.80	2.20
B	1.15	1.35
C	0.90	1.10
D	0.10	0.35
G	0.65BSC	
H	0.00	0.10
J	0.08	0.25
K	0.15	0.40
E	2.15	2.45

Part NO.	Description	工作电压	动作电压	箝位电压	泄漏电流	结电容	极限电流	功能图
		VRWM	VBR	VC@1A	IR	CJ	IPP	Fig
		V	V	V	uA	pF	A	
SMF05	5V, 4-Line, Uni	5	6	10	0.1	15	2.5	Fig 1
SMF12	12V, 4-Line, Uni	12	13	13	1	50	2.5	Fig 1

功能图标识

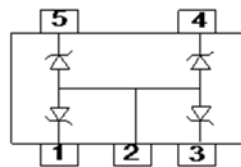
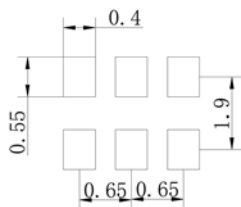

Fig 1

对应型号系列	包装形式	卷盘直径	每盘/盒数量	每箱数量	外包装箱尺寸		
		mm	PCS	PCS	L(mm)	W(mm)	H(mm)
SOT-353封装产品	盘装	178	3,000	120,000	438	438	220

瞬态电压抑制器阵列 ESD/TVS Array

SOT-363封装产品



PAD LAYOUT

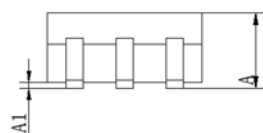
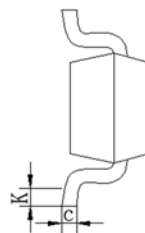
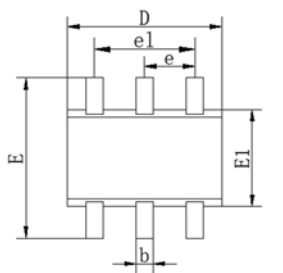

DIM	Millimeters	
	Min	Max
A	0.90	1.10
A1	0.00	0.10
B	0.10	0.35
c	0.08	0.25
D	2.00	2.20
e	0.65BSC	
e1	1.20	1.40
E	2.00	2.45
E1	1.15	1.35
K	0.15	0.46

Part NO.	Description	工作电压	动作电压	箝位电压	泄漏电流	结电容	极限电流	功能图
		VRWM V	VBR V	VC@1A V	IR uA	CJ pF	IPP A	Fig
CLAMP0504F	5V, 4-Line, Uni, UltraLow Cap	5	6	9	1	0.8	5	Fig 2
CLAMP0504FG	5V, 4-Line, Uni, UltraLow Cap	5	6	7.8	1	0.45	4	Fig 2
CLAMP0504FP	5V, 4-Line, Uni, UltraLow Cap	5	6	8.5	1	0.8	5	Fig 2
CLAMP0504FT	5.5V, 4-Line, Uni, UltraLow Cap	5.5	6	7.8	1	0.45	4	Fig 2
CLAMP0514FG	5V, 4-Line, Uni, UltraLow Cap	5	6	7.8	1	0.45	4	Fig 4
WPE2202W1	5V, 2-Line, Uni, UltraLow Cap	5	6	15.5	1	0.9	5	Fig 1
SMF03C	3V, 4-Line, Uni	3	5.3	10	0.1	18	2.5	Fig 3
SMF05C	5V, 5-Line, Uni	5	6	10	0.1	15	2.5	Fig3

功能图标识

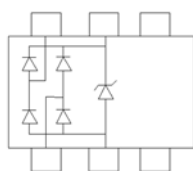

Fig 1

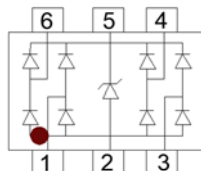

Fig 2

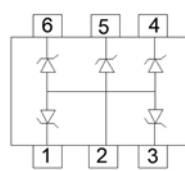

Fig 3

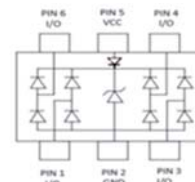
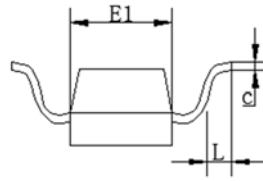
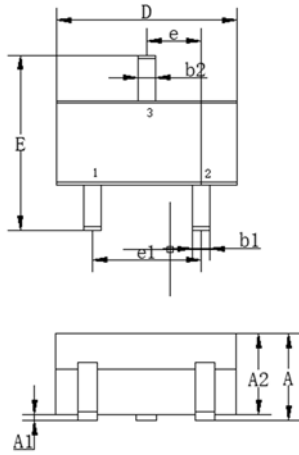
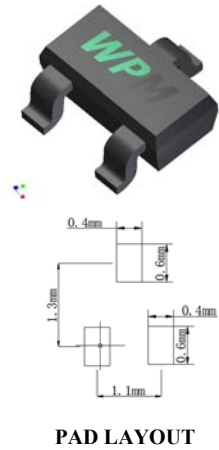

Fig 4

对应型号系列	包装形式	卷盘直径	每盘/盒数量	每箱数量	外包装箱尺寸		
		mm	PCS	PCS	L(mm)	W(mm)	H(mm)
SOT-363封装产品	盘装	178	3,000	120,000	438	438	220

瞬态电压抑制器阵列 ESD/TVS Array

SOT-523封装产品



DIM	Millimeters	
	Min	Max
A	0.70	0.95
A1	0.10BSC	
A2	0.65	0.85
c	0.05	0.20
D	1.50	1.70
E	1.45	1.75
E1	0.70	0.90
b1	0.15	0.25
b2	0.25	0.35
e	0.50TYP	
e1	0.90	1.10
L	0.26	0.46

Part NO.	Description	工作电压	动作电压	箝位电压	泄漏电流	结电容	极限电流	功能图
		VRWM	VBR	VC@1A	IR	CJ	IPP	Fig
		V	V	V	uA	pF	A	
WPE05CT52BLA	5V, 2-Line, Bi	5	6	12	0.1	2.5		Fig 2
WPE05VT52UL	5V, 2-Line, Uni, UltraLow Cap	5	6	13	1	0.9		Fig 1
WPE6V8T52BL	5V, 2-Line, Uni	5	6	7.8	2	25		Fig 1

功能图标识

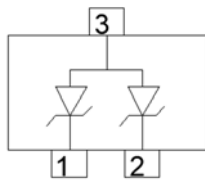

Fig 1

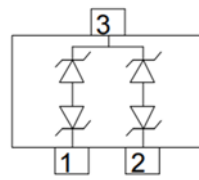
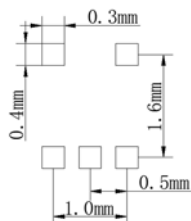

Fig 2

对应型号系列	包装形式	卷盘直径	每盘/盒数量	每箱数量	外包装箱尺寸		
		mm	PCS	PCS	L(mm)	W(mm)	H(mm)
SOT-523封装产品	盘装	178	3,000	120,000	438	438	220

瞬态电压抑制器阵列 ESD/TVS Array

SOT-553封装产品



PAD LAYOUT

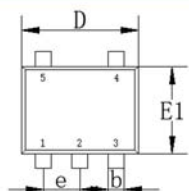

Top View

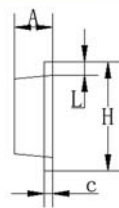

Side View

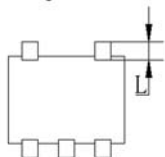

Bottom View

DIM	Millimeters	
	Min	Max
A	0.50	0.60
b	0.15	0.30
c	0.09	0.16
D	1.50	1.70
E1	1.10	1.30
e	0.50BSC	
L	0.10	0.30
H	1.50	1.70

Part NO.	Description	工作电压	动作电压	箝位电压	泄漏电流	结电容	极限电流	功能图
		VRWM	VBR	VC@1A	IR	CJ	IPP	Fig
		V	V	V	uA	pF	A	
NZQA6V8AW5	5V, 4-Line, Uni	5	6	10	0.1	15	2.5	Fig 1

功能图标识

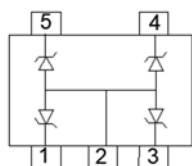
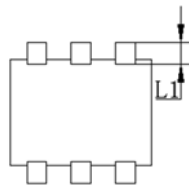
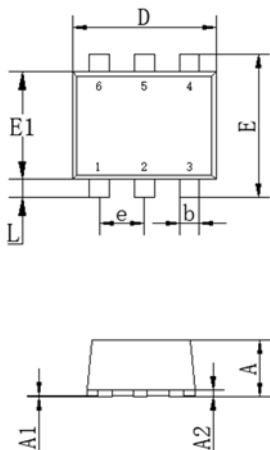
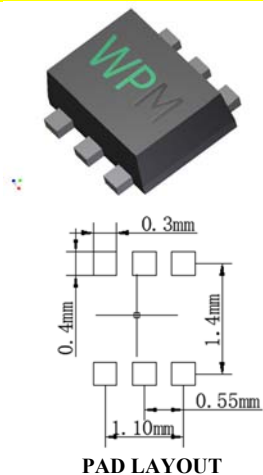

Fig 1

对应型号系列	包装形式	卷盘直径	每盘/盒数量	每箱数量	外包装箱尺寸		
		mm	PCS	PCS	L(mm)	W(mm)	H(mm)
SOT-553封装产品	盘装	178	3,000	120,000	438	438	220

瞬态电压抑制器阵列 ESD/TVS Array

SOT-563封装产品



DIM	Millimeters	
	Min	Max
A	0.525	0.600
A1	0.00	0.05
A2	0.17	0.27
b	0.09	0.16
D	1.50	1.70
E	1.500	1.700
e	0.450	0.550
E1	1.100	1.300
L	0.100	0.300
L1	0.200	0.400

Part NO.	Description	工作电压	动作电压	箝位电压	泄漏电流	结电容	极限电流	功能图
		VRWM V	VBR V	VC@1A V	IR uA	CJ pF	IPP A	Fig
CLAMP0502S	5V, 2-Line, Uni, UltraLow Cap	5	6	15.5	1	0.8	5	Fig 1
CLAMP0504S	5V, 4-Line, Uni, UltraLow Cap	5	6	15.5	1	0.8	4	Fig 3
WPE5605C	5V, 5-Line, Uni	5	6	9.5	0.5	17	3	Fig 2

功能图标识

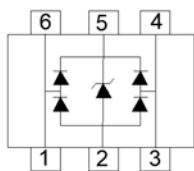

Fig 1

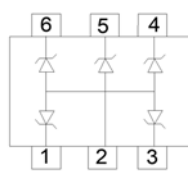

Fig 2

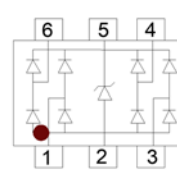
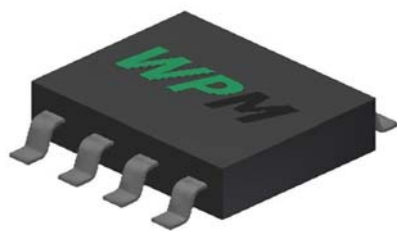

Fig 3

对应型号系列	包装形式	卷盘直径	每盘/盒数量	每箱数量	外包装箱尺寸		
		mm	PCS	PCS	L(mm)	W(mm)	H(mm)
SOT-563封装产品	盘装	178	3,000	120,000	438	438	220

瞬态电压抑制器阵列 ESD/TVS Array

SOP-8封装产品



PAD LAYOUT

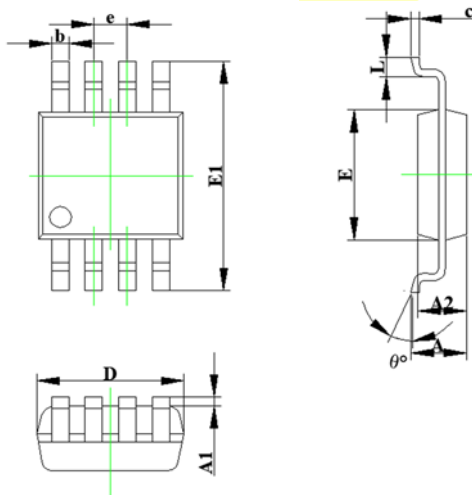

DIM	Millimeters	
	Min	Max
A	4.80	5.00
E	6.00BCS	
E1	3.80	4.40
b	0.33	0.51
C	1.35	1.55
J	0.17	0.225
e	1.27BCS	
K	0.40	1.27
H	0.10	0.25

Part NO.	Description	工作电压	动作电压	箝位电压	泄漏电流	结电容	极限电流	功能图
		VRWM	VBR	VC@1A	IR	CJ	IPP	Fig
		V	V	V	uA	pF	A	
LC03-3.3	3.3V, 4-Line, Uni	3.3	3.5 2.8	18.5@50	1	13	100	Fig 2
LC03-6	6V, 4-Line, Uni	6	6	20	25	8	100	Fig 2
SLVU2.8-4	2.8V, 4-Line, Bi	2.8	3 2.8	7.6	1	1.5	25	Fig 1
SLVU2.8-4L	2.8V, 4-Line, Bi, UltraLow Cap	2.8	3 2.8	7.6	1	0.65	20	Fig 1
SMDA03-8	3.3V, 4-Line, Bi	3.3	4	7.6	20	180		Fig 3
SMDA05-8	5V, 4-Line, Bi	5	5.6	9.8	5	160		Fig 3
SMDA08-8	8V, 4-Line, Bi	8	8.5	13.4	1	110		Fig 3
SMDA12-8	12V, 4-Line, Bi	12	13.3	19	1	43		Fig 3
SMDA15-8	15V, 4-Line, Bi	15	16.7	24	1	40		Fig 3
SMDA24-8	24V, 4-Line, Bi	24	26.7	43	1	35		Fig 3

功能图标识

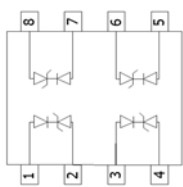

Fig 1

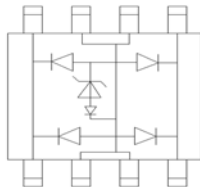

Fig 2

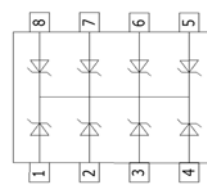
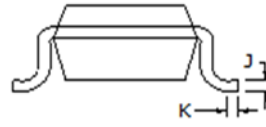
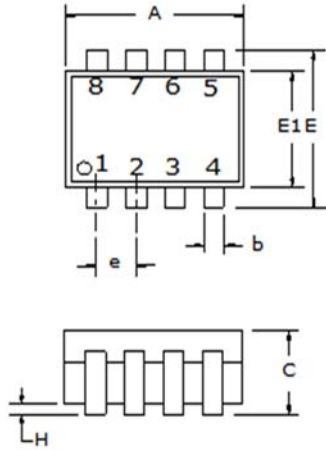
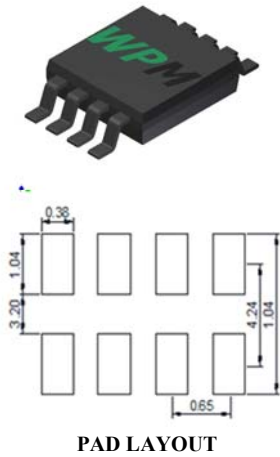

Fig 3

对应型号系列	包装形式	卷盘直径	每盘/盒数量	每箱数量	外包装箱尺寸		
		mm	PCS	PCS	L(mm)	W(mm)	H(mm)
SOP-8封装产品	盘装	178	2,500	100,000	438	438	220

瞬态电压抑制器阵列 ESD/TVS Array

MSOP-8封装产品



DIM	Millimeters	
	Min	Max
A	2.90	3.10
E	4.75	5.05
E1	2.90	3.10
b	0.25	0.40
C	1.00	1.10
J	0.13	0.25
e	0.65BSC	
K	0.40	0.70
H	0.05	0.15

Part NO.	Description	工作电压	动作电压	箝位电压	泄漏电流	结电容	极限电流	功能图
		VRWM	VBR	VC@1A	IR	CJ	IPP	Fig
		V	V	V	uA	pF	A	
CLAMP0506M	5V, 7-Line, Uni, UltraLow Cap	5	6	18	1	0.3	3	Fig 1

功能图标识

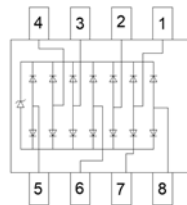
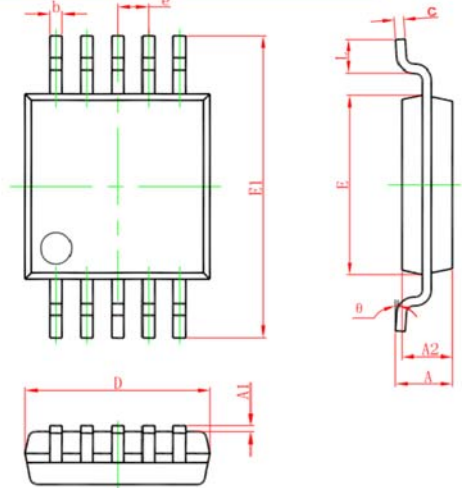
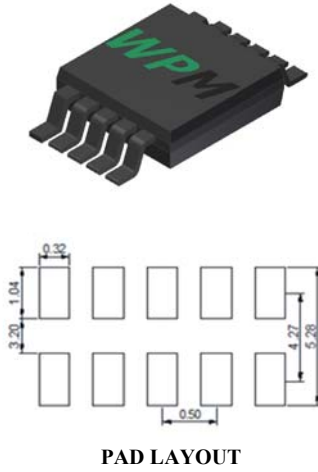

Fig 1

对应型号系列	包装形式	卷盘直径	每盘/盒数量	每箱数量	外包装箱尺寸		
		mm	PCS	PCS	L(mm)	W(mm)	H(mm)
MSOP-8封装产品	盘装	178	3,000	120,000	438	438	220

瞬态电压抑制器阵列 ESD/TVS Array

MSOP-10封装产品



DIM	Millimeters	
	Min	Max
A	0.82	1.10
A1	0.02	0.15
A2	0.75	0.95
b	0.18	0.28
c	0.09	0.23
D	2.90	3.10
E	2.90	3.20
E1	4.75	5.05
e	0.50BSC	
L	0.40	0.80

Part NO.	Description	工作电压	动作电压	箝位电压	泄漏电流	结电容	极限电流	功能图
		VRWM	VBR	VC@1A	IR	CJ	IPP	Fig
		V	V	V	uA	pF	A	
CLAMP0544M	5V, 5-Line, Uni, UltraLow Cap	5	6	15.5	1	0.65	5	Fig 1

功能图标识

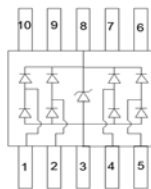
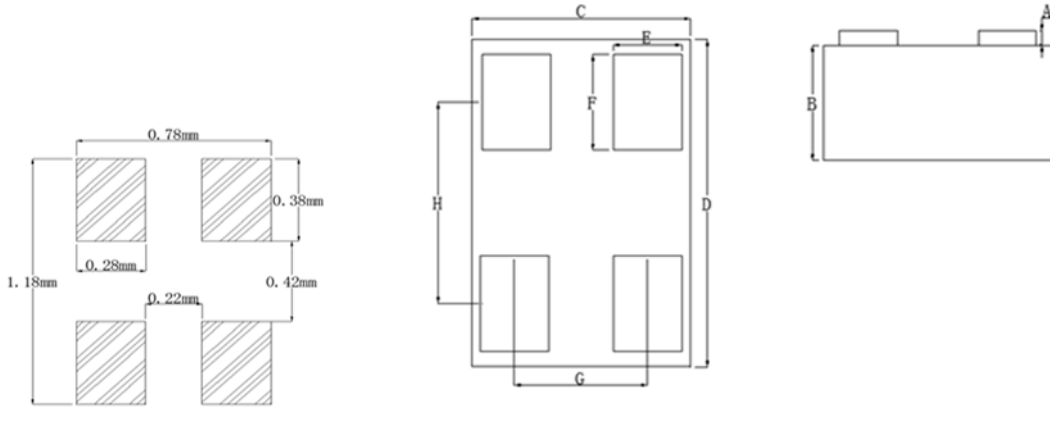

Fig 1

对应型号系列	包装形式	卷盘直径	每盘/盒数量	每箱数量	外包装箱尺寸		
		mm	PCS	PCS	L(mm)	W(mm)	H(mm)
MSOP-10封装产品	盘装	178	3,000	120,000	438	438	220

瞬态电压抑制器阵列 ESD/TVS Array

TSLP-4-7封装产品



DIM	Millimeters	
	Min	Max
A	0.01	0.05
B	0.36	0.4
C	0.75	0.85
D	1.15	1.25
E	0.215	0.285
F	0.315	0.385
G	0.4	0.5
H	0.7	0.8

Part NO.	Description	工作电压	动作电压	箝位电压	泄漏电流	结电容	极限电流	功能图
		VRWM	VBR	VC@1A	IR	CJ	IPP	Fig
		V	V	V	uA	pF	A	
WPE0P8RFL	50V, 2-Line, Uni, UltraLow Cap	50 _{MAX}		12V @10A	0.10	0.8	10	Fig 1

功能图标识

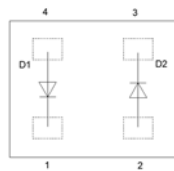

Fig 1

对应型号系列	包装形式	卷盘直径	每盘/盒数量	每箱数量	外包装箱尺寸		
		mm	PCS	PCS	L(mm)	W(mm)	H(mm)
TSLP-4-7封装产品	盘装	178	3,000	120,000	438	438	220



上海维攀微电子有限公司

Shanghai WPM Electronic Co., Ltd.



上海漕河泾开发区松江高科技园莘砖公路258号33幢803室

Room 803,33th Building, No 258, Caohejing Hi-tech Park,
XinZhuan Road, Songliang District,ShangHai



(+8621) 6784 1922



(+8621) 5762 1210



support@wpmsemi.com